

PONDEROSA

HOMES

PUD-97

May 8, 2013

Ms. Natalie Amos
Associate Planner
City of Pleasanton
Post Office Box 520
Pleasanton, CA 94588

Re: Wagner Property; PUD-97, RZ

Dear Ms. Amos:

Please find enclosed the revised Project plans to accompany this revised Project Description letter for the subject application.

Since meeting together in early April of this year, we have worked hard to revise the Project to respond to City Staff comments. Most notably, we have modified the proposal to eliminate the proposed demolition of the existing house at 4202 Stanley Boulevard resulting from feedback by various members of the Historical Preservation Task Force desiring that the house remain due to its age, design, and location within the downtown area. The property owners have decided to retain the old house on a 0.22 acre lot which will allow them flexibility to market the property to potential future owners that could be interested in upgrading the structure either as residential or perhaps commercial tenant use compatible with residential homes in the surrounding area (similar to the adjacent home at 4216 Stanley Blvd.).

In summary, the primary changes to the proposal are as follows:

1. Retain and preserve the existing old house on a new 0.22 acre lot;
2. Reduce the overall number of new residential lots from 15 to 12 (or 12 lots plus a remainder lot to total 13) and increase the minimum new lot size from 3,633 to 3,715 square feet; the clarification regarding the OS-PH & WO overlay delineation and developable acreage results in a density of 7.3 du/ac. A public amenity is required to exceed the mid-point density and is yet to be determined; the creation of a large parcel upon which the old house will remain (thus reducing the project scope) could be considered a qualifying amenity, along with park fee contribution. We look forward to additional discussion in this regard, however the Project does not propose an on-site park or open space amenity;
3. Reduce the number of lots along the western portion of the site from seven to five lots (including the existing house lot), and increase the lot size (Lots 1 – 3) to an approximate minimum of 4,360 sq.ft. instead of the previous 3,633 sq.ft. minimum;

4. Increased minimum lot sizes and reduced F.A.R. ranging overall from 0.38 to 0.70 depending upon the specific house plotting; a preliminary plotting plan is provided to demonstrate F.A.R. ranges per individual lot as well as the overall summary;
5. Designate the access serving the new homes as a private rather public street and increase street parking to total 12 vehicles instead of nine, and increase the length of driveways if possible to exceed 20 feet;
6. Eliminate the pedestrian walkway connecting with Verais; the location of this infill site within the downtown makes it "walkable" to services along Stanley Boulevard and thus unnecessary to impact existing Vervais residents;
7. Increase the side yard setback to five and six feet on a majority of the lots on the eastern portion of the site. With the exception of Lot 5, the lots flanking the arroyo area (Lots 4, 6 and 7) will have a minimum 6.5 or greater side yard setback with a 13 to 14 feet aggregate between buildings. Previously a minimum aggregate of ten feet was proposed; and
8. Designate the Plan 1SR on Lot 12 thus having a full length and wrap-around porch to front onto Stanley Boulevard consistent with the downtown character; porches are provided on all of the homes as is other architectural forms such as lap siding, corbels, varied roof designs (hipped, gable and shed combinations).

Regarding affordable units, the Project requires 2.4 units. Ponderosa will utilize 4.0 credits available under the existing Ironwood Affordable Housing Agreement, plus additional fees to comply with this requirement. Also for clarification, the Project does not propose Stanley Boulevard frontage improvements other than the new private street tie-in and necessary utility connections, thus pro-rata share fees will be paid towards the City CIP.

Ponderosa will work together with Mr. Swift regarding an enhanced fence or masonry wall along the shared east boundary line; however, at this time we must ascertain the number of lots that will ultimately approved along with having an understanding of the associated grading, survey of boundary lines and potential encroachments onto the property, etc. prior to a commitment. We anticipate the treatment of the shared boundary will be resolved during the tentative map phase of the Project.

Lastly, the Tree Report was updated to clarify the difference between Condition Rating of trees and their recommended Preservation for Suitability. While additional trees beyond the initial proposal will be retained as a result of the 0.22 lot creation (and thus no additional grading in those areas), no other trees are recommended for preservation.

We look forward to discussing the Project merits with the City Staff and to secure a Planning Commission hearing at the earliest opportunity. I can be reached at 925.460.8981.

Very truly yours,

PONDEROSA HOMES II, INC.

Pamela J. Hardy

Senior Manager, Land Planning

See Attachments – Next Page



© 2013 WILLIAM HEZMALHALCH ARCHITECTS, INC.



PONDEROSA
HOMES



RIPLEY DESIGN GROUP, INC.
1615 BONANZA STREET
SUITE 314
WALNUT CREEK, CA 94596
T: 925-938-7377
F: 925-938-7436

WAGNER SITE

Pleasanton, California
Ponderosa Homes

May 22, 2013



RUGGERI-JENSEN-AZAR
ENGINEERS • PLANNERS • SURVEYORS
4690 CHAYO DRIVE, SUITE 200, PLEASANTON, CA 94586
PHONE: (925) 227-9700 FAX: (925) 227-9300



WILLIAM HEZMALHALCH
ARCHITECTS, INC.
5000 EXECUTIVE PKWY SUITE 375 SAN RAMON CA 94583-4210
949 250 0607 www.architects.com fax 949 250 1529
2850 REDHILL AVENUE SUITE 200 SANTA ANA CA 92705-5543
949 250 0607 fax 949 250 1529

LEGEND

PROPOSED	DESCRIPTION	EXISTING
---	TRACT BOUNDARY	
---	LOT LINE	
---	RIGHT OF WAY	
---	CENTER LINE	
---	MATCH LINE	
---	RETAINING WALL	
---	EASEMENT LINE	
---	STORM DRAIN	EX 12"SD
---	SANITARY SEWER	EX 8"SS
---	WATER	EX 8"W
---	RECYCLED WATER	EX 8"W(R)
---	CURB & GUTTER	EX FC
---	SIDEWALK	
---	OVERHEAD UTILITIES	
---	JOINT POLE	
---	EARTH OR GRASS SWALE	
---	CONCRETE DITCH	
---	STORM WATER INLET	□
---	FIELD INLET	□
---	AREA DRAIN	□
---	DIRECTION OF FLOW	○
---	MANHOLE	○
---	FIRE HYDRANT	○
---	BLOW OFF	○
---	SANITARY SEWER CLEAN OUT	○
---	WATER VALVE	○
---	STREET LIGHT	○
---	MONUMENT	○
---	TRAFFIC SIGN	○
---	STREET NAME SIGN	○
---	FENCE	○
---	BARRICADE	○
---	SLOPE	○
---	HANDICAP RAMP	○
---	SAVE TREE	+ 20" OAK (S)
---	REMOVE TREE	X
---	CONTOUR ELEVATIONS	
---	SPOT ELEVATION	525.2
---	ASPHALT PAVEMENT	
---	BIORETENTION AREA	
ABBREVIATIONS		
AB	AGGREGATE BASE	
AC	ASPHALT CONCRETE	
AD	AREA DRAIN	
BC	BEGINNING OF CURVE	
BVC	BEGIN VERTICAL CURVE	
BO	BLOW OFF	
BW	BOTTOM OF WALL	
CL	CENTER LINE	
CMP	CORRUGATED METAL PIPE	
CP	CENTER POINT	
DWY	DRIVEWAY	
DIP	DUCTILE IRON PIPE	
EC	END OF CURVE	
EVC	END VERTICAL CURVE	
EVAE	EMERGENCY VEHICLE ACCESS EASEMENT	
EX	EXISTING	
FC	FACE OF CURB	
FG	FINISHED GRADE	
FH	FIRE HYDRANT	
FI	FIELD INLET	
FL	FLDW LINE	
GB	GRADE BREAK	
GR	GRATE	
HP	HIGH POINT	
INV	INVERT ELEVATION	
JP	JOINT POLE	
LP	LOW POINT	
ME	MAINTENANCE EASEMENT	
MH	MANHOLE	
OH	OVERHEAD UTILITIES	
PAE	PRIVATE ACCESS EASEMENT	
PCC	POINT OF COMPOUND CURVE	
PL	PROPERTY LINE	
PRC	POINT OF REVERSE CURVE	
PSDE	PRIVATE STORM DRAIN EASEMENT	
PSE	PUBLIC SERVICE EASEMENT	
PVC	POLYVINYL CHLORIDE PIPE	
PVI	POINT OF VERTICAL INTERSECTION	
RCP	REINFORCED CONCRETE PIPE	
RET	CURB RETURN	
RW	RIGHT OF WAY	
SDE	STORM DRAIN EASEMENT	
SNS	STREET NAME SIGN	
SO	SIDE OPENING INVERT	
SSCO	SANITARY SEWER CLEAN OUT	
STA	STATION	
SWI	STORM WATER INLET	
SWK	SIDEWALK	
TC	TOP OF CURB	
TW	TOP OF WALL	
WM	WATER METER	
VC	VERTICAL CURVE	
VCP	VITRIFIED CLAY PIPE	

PLANNED UNIT DEVELOPMENT WAGNER PROPERTY CITY OF PLEASANTON, ALAMEDA COUNTY, CALIFORNIA

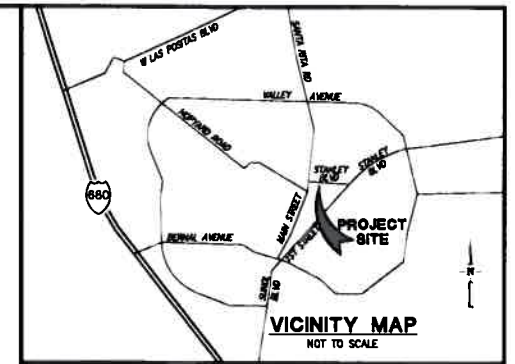

SHEET INDEX

SHEET NO.	DESCRIPTION
PLANNING, ENGINEERING	
1	COVER SHEET
2	SITE DEVELOPMENT PLAN
3	PRELIMINARY GRADING & UTILITY PLAN
4	EXISTING CONDITIONS
5	SLOPE MAP
6	STORMWATER MANAGEMENT PLAN
7	EXISTING TREES
ARCHITECTURE	
1.1	PLAN 1
1.2	PLAN 1
1.3	PLAN 1
1.4	PLAN 1
1.5	PLAN 1
1.6	PLAN 1-S
1.7	PLAN 1-S
2.1	PLAN 2
2.2	PLAN 2
2.3	PLAN 2
2.4	PLAN 2
2.5	PLAN 2
3.1	PLAN 3
3.2	PLAN 3
3.3	PLAN 3
3.4	PLAN 3
3.5	PLAN 3
LANDSCAPE ARCHITECTURE	
L1	PRELIMINARY LANDSCAPE SITE PLAN
L2	PRELIMINARY LANDSCAPE STREETSCAPE
L3	PRELIMINARY LANDSCAPE DETAILS

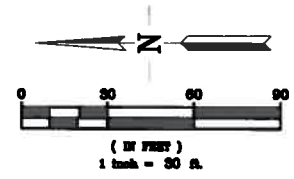
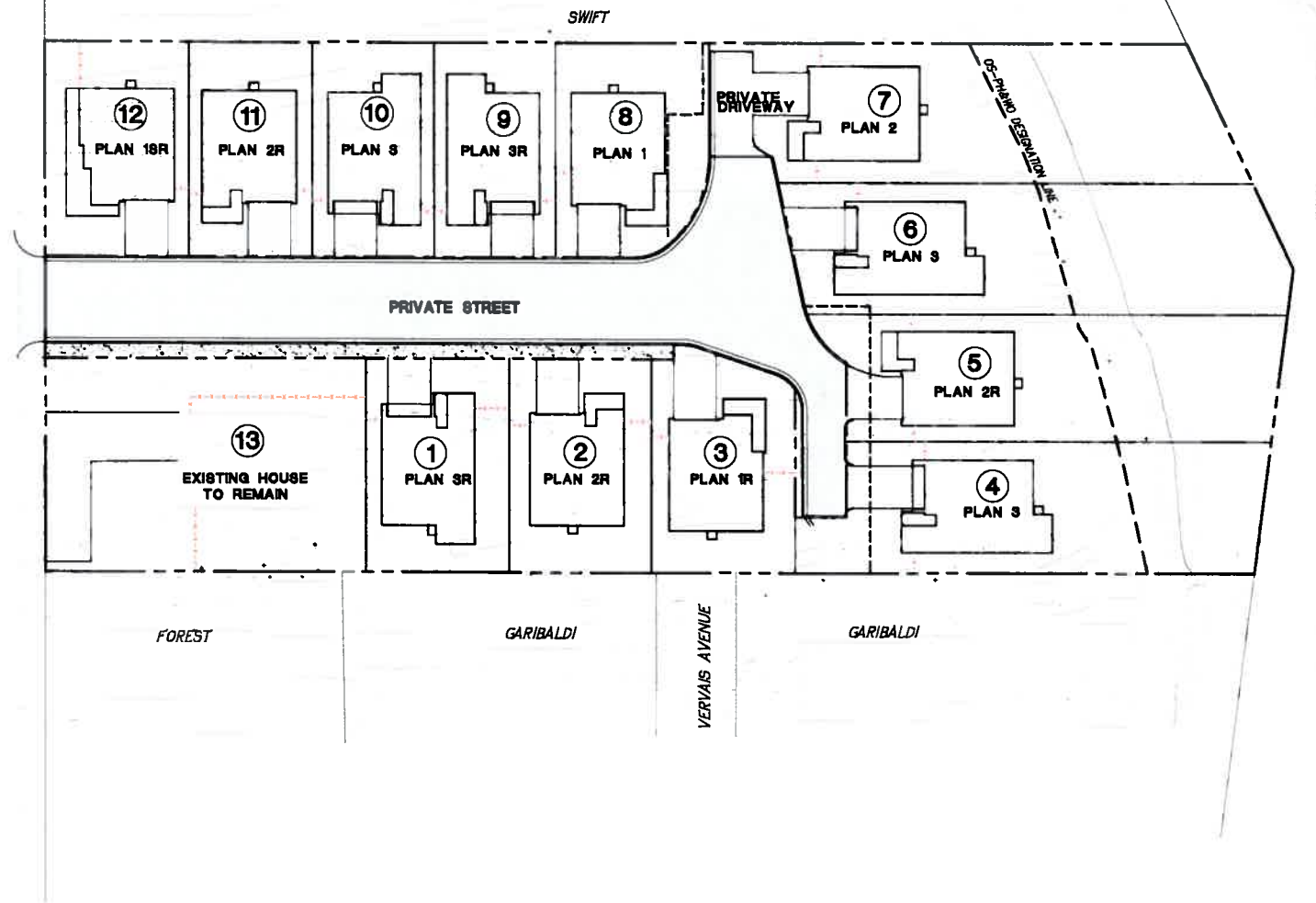

PROJECT TEAM

Applicant
Ponderosa Homes II, Inc.
 6130 Stoneridge Mall Road, #185
 Pleasanton, CA 94588
 Contact: Pamela Hardy
 (925) 460-8800

Civil Engineering & Planning

Ruggeri-Jensen-Azar
 4690 Chabot Drive, Suite 200
 Pleasanton, CA 94588
 Contact: Mark Faigout
 (925) 227-9100

Landscape Architecture

Ripley Design Group
 1615 Bonanza Street, Suite 314
 Walnut Creek, CA 94596
 Contact: Anika Carpenter
 (925) 938-7377

Architecture

William Hezmalhalch Architects, Inc.
 5000 Executive Parkway, Suite 375
 San Ramon, CA 94583
 Contact: MARK RUTHERFORD
 (925) 627-1166

Soils Engineer

Cornerstone Earth
 2737 N. Main Street, Suite 10
 Walnut Creek, CA 94597
 Contact: John Dye
 (925) 988-9500



RUGGERI-JENSEN-AZAR
 ENGINEERS • PLANNERS • SURVEYORS
 4690 CHABOT DRIVE, SUITE 200, PLEASANTON, CA 94588
 PHONE: (925) 227-9100 FAX: (925) 227-9300

PUD LOT SPECIFICATIONS SUMMARY

LOT	GROSS LOT SIZE (1)	NET LOT SIZE (2)	HOUSE MODEL (3)	HOUSE MODEL MAX HEIGHT (4)	HOUSE SIZE (5)	FAR (6)	MIN FRONT SETBACK (PORCH/HOUSE/DWY)	MIN REAR SETBACK	MIN SIDE SETBACK
1	4,360	4,360	PLAN 2 OR 3	32'	2,226-2,624	51 OR 60%	5'11"/20'	10'	5'
2	4,360	4,360	PLAN 2 OR 3	32'	2,226-2,624	51 OR 60%	5'11"/20'	10'	5'
3	4,358	4,358	PLAN 1	32'	2,261	52%	5'11"/20'	10'	5'
4	8,330	5,821	PLAN 2 OR 3	32'	2,226-2,624	38 OR 45%	5'11"/20'	10'	5'
5	8,046	4,750	PLAN 2 OR 3	32'	2,226-2,624	47 OR 55%	5'11"/20'	10'	5'
6	9,136	4,931	PLAN 2 OR 3	32'	2,226-2,624	45 OR 53%	5'11"/20'	10'	5'
7	9,898	5,599	PLAN 2 OR 3	32'	2,226-2,624	40 OR 47%	5'11"/20'	10'	5'
8	4,450	4,450	PLAN 1	32'	2,261	51%	5'11"/20'	10'	5'
9	3,715	3,715	PLAN 2 OR 3	32'	2,226-2,624	60 OR 71%	5'11"/20'	10'	5'
10	3,715	3,715	PLAN 2 OR 3	32'	2,226-2,624	60 OR 71%	5'11"/20'	10'	5'
11	3,755	3,755	PLAN 2 OR 3	32'	2,226-2,624	60 OR 70%	5'11"/20'	10'	5'
12	4,401	4,401	PLAN 1S	32'	2,182	50%	5'11"/20'	10'	5'
13	9,878	9,878	EXISTING HOUSE	N/A	< 2,000	< 20%	10'/19'/19'	14'	N/A

NOTES:
 (1) GROSS LOT SIZE INCLUDES AREA WITHIN THE OS-PH&WO.
 (2) NET LOT SIZE DOES NOT INCLUDE AREAS WITHIN THE OS-PH&WO.
 (3) PLOTTING MIX SHOWN IS PRELIMINARY ONLY. SPECIFIC PLAN TYPE PER LOT TO BE DETERMINED BY APPLICANT.
 (4) FOR SPECIFIC BUILDING HEIGHTS, SEE ARCHITECTURAL PLANS.
 (5) PRELIMINARY SQUARE FOOTAGES ARE APPROXIMATE.
 (6) FAR IS CALCULATED USING NET LOT AREA.

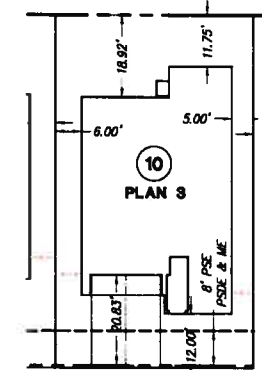

SITE SUMMARY

NUMBER OF NEW UNITS:	12
NUMBER OF EXISTING UNITS TO REMAIN:	1
SITE ACRES:	2.11 ACRES
DEVELOPED ACRES (LOTS AND STREETS):	1.78
GROSS DENSITY (NEW DEVELOPMENT) # UNITS / (TOTAL AC - OS-PH&WO-EX HOUSE)AC:	7.7 DU/AC
GROSS DENSITY (ALL RESIDENTIAL) # UNITS / (TOTAL AC - OS-PH&WO)AC:	7.3 DU/AC
PARKING ON STREET:	12
DRIVEWAYS (2 MINIMUM PER NEW RESIDENCE):	24
GARAGE (2 PER NEW RESIDENCE):	24
TOTAL:	60 TOTAL

LAND USE SUMMARY

LAND USE	UNITS	ACRES	% OF SITE
MEDIUM DENSITY RESIDENTIAL (MDR) SINGLE FAMILY DETACHED	12	1.25	59.2%
OS-PH&WO	-	0.33	15.7%
RIGHT OF WAY (STREETS & SIDEWALKS)	-	0.31	14.7%
EXISTING HOUSE (LOT 13)	-	0.22	10.4%
TOTAL	12	2.11	100.0%

NOTE:
 *NET LOT AREAS USED FOR SINGLE FAMILY DETACHED LAND USE CALCULATION. THE REMAINING AREA IS A PART OF THE OS-PH&WO AREA, PROPOSED PRIVATE STREET RIGHT OF WAY AND EXISTING HOUSE LOT.

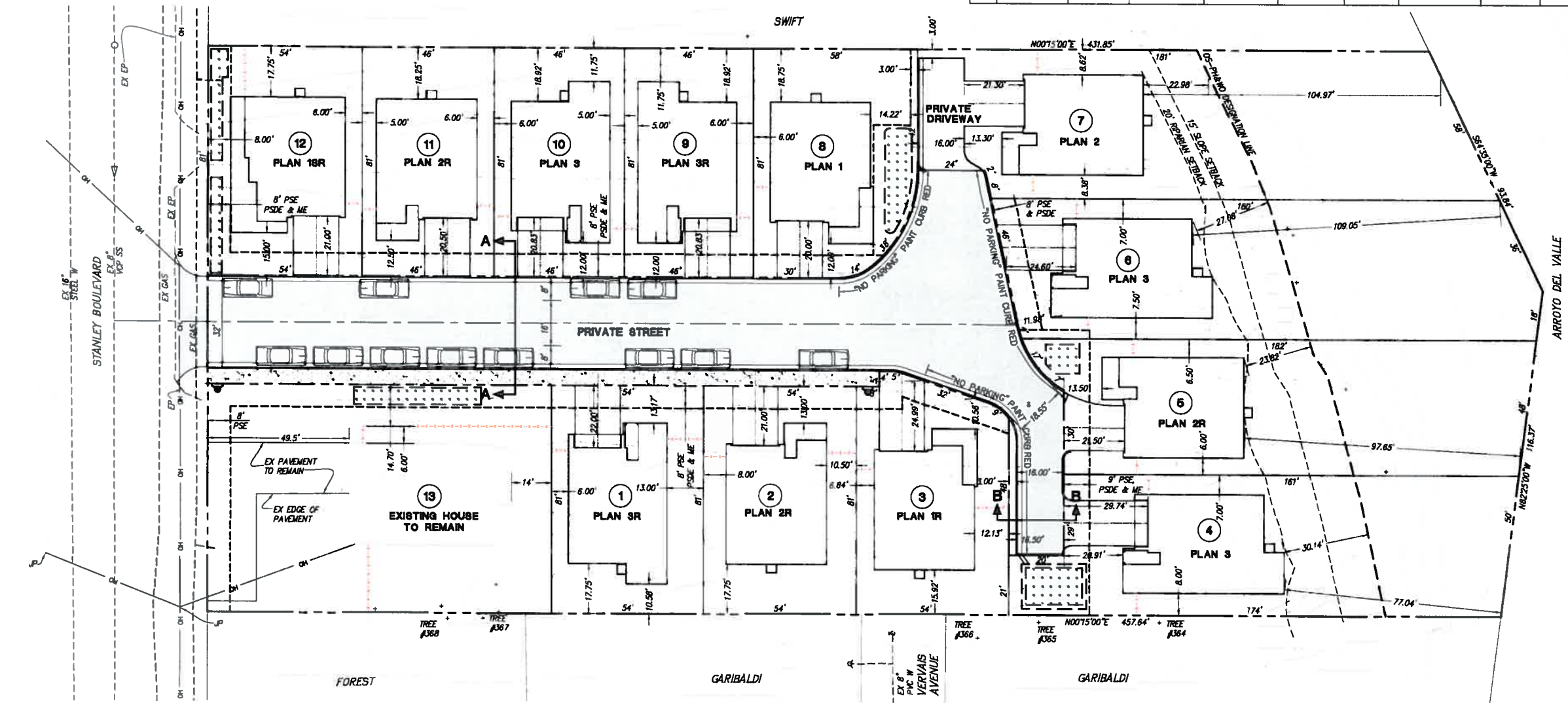

ACCESSORY STRUCTURES

LOTS	MINIMUM SETBACK (SEE NOTES BELOW)
1-3, 8-12	5' TO SIDE PL 5' TO REAR PL CLASS I, UNENCLOSED TRELIS, ARBOR, AND SHEDS 7' > HEIGHT
4-7	5' TO SIDE PL MAXIMUM 10' PROJECTION FROM REAR BLDG WALL AND NO ENCROACHMENT WITHIN 15' SLOPE SETBACK LINE
1-12	CLASS II, POOLS NOT ALLOWED AND POSSIBLE HOT TUBS PER CLASS I REGULATIONS CLASS I, HABITABLE STRUCTURE NOT ALLOWED

NOTES:
 1. FRONT, SIDE, REAR YARD SETBACKS DO NOT INCLUDE MINOR ARCHITECTURAL PROJECTIONS PER CITY OF PLEASANTON ZONING ORDINANCE.

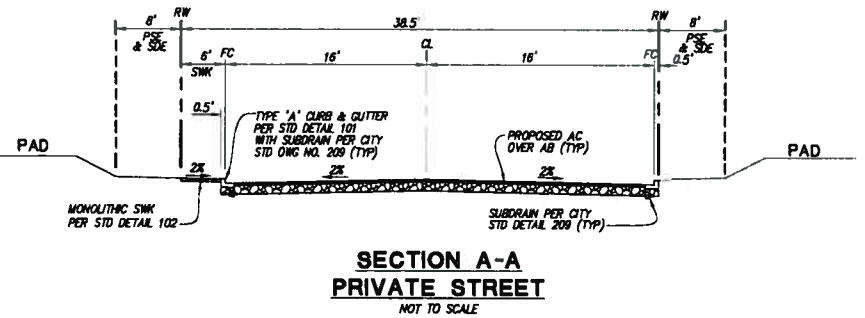

SITE DEVELOPMENT PLAN
WAGNER PROPERTY
 CITY OF PLEASANTON, ALAMEDA COUNTY, CALIFORNIA

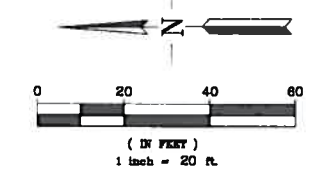
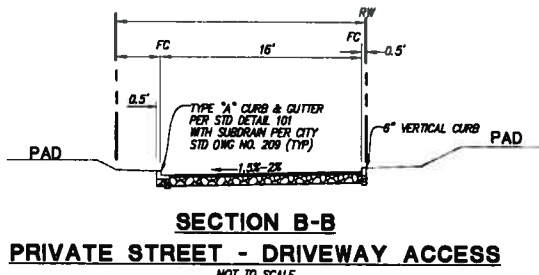

RJA
RUGGERI-JENSEN-AZAR
 ENGINEERS • PLANNERS • SURVEYORS
 4690 CHABOT DRIVE, SUITE 200, PLEASANTON, CA 94588
 PHONE: (925) 227-9100 FAX: (925) 227-9300

MATCH LINE - STA 17+10.00
SEE RIGHT

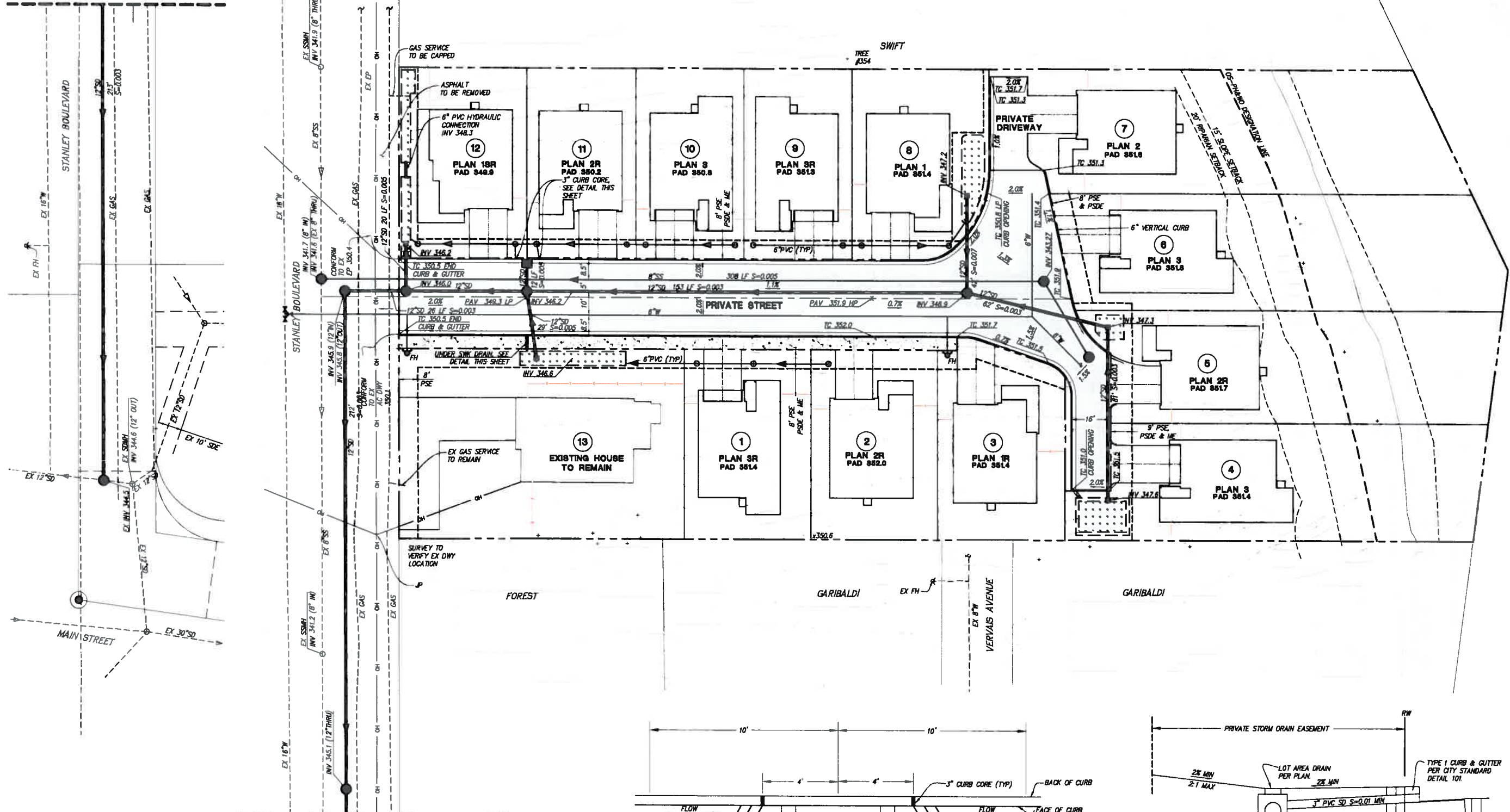

MATCH LINE - STA 17+10.00
SEE LEFT

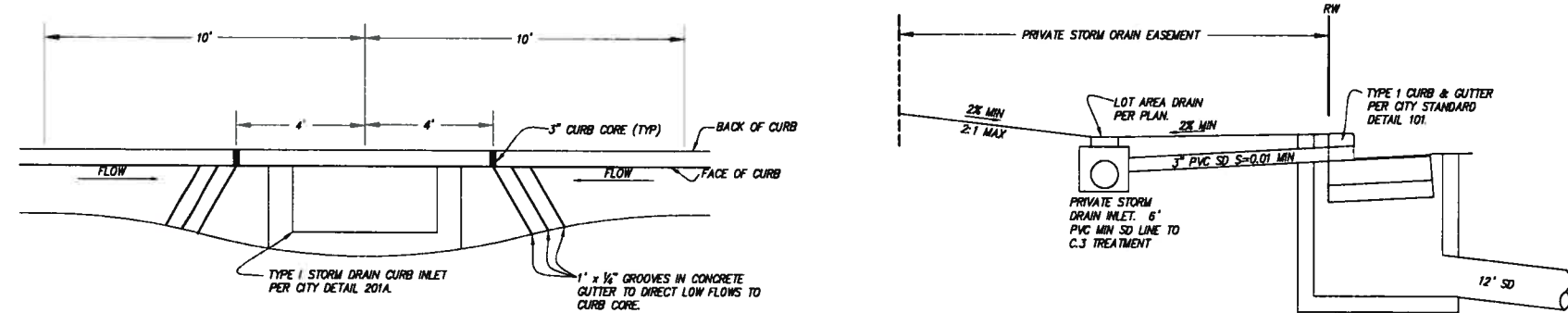
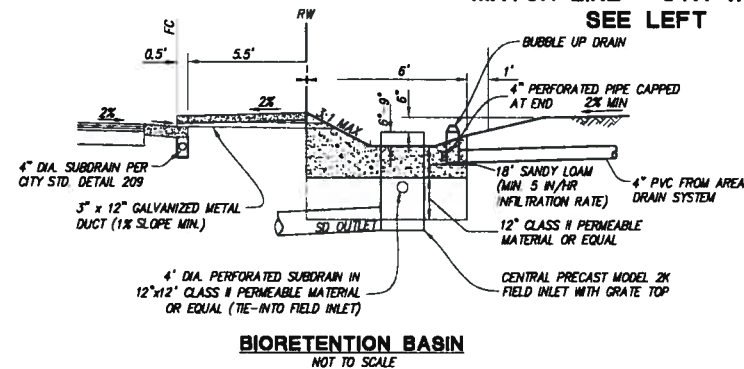

GRADING AND UTILITY PLAN

WAGNER PROPERTY

CITY OF PLEASANTON, ALAMEDA COUNTY, CALIFORNIA

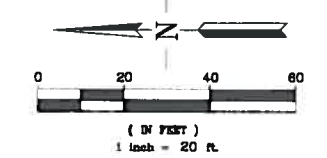

RJA
RUGGERI-JENSEN-AZAR
ENGINEERS • PLANNERS • SURVEYORS
1690 CHABO DRIVE, SUITE 200, PLEASANTON, CA 94588
PHONE: (925) 227-9100 FAX: (925) 227-9300

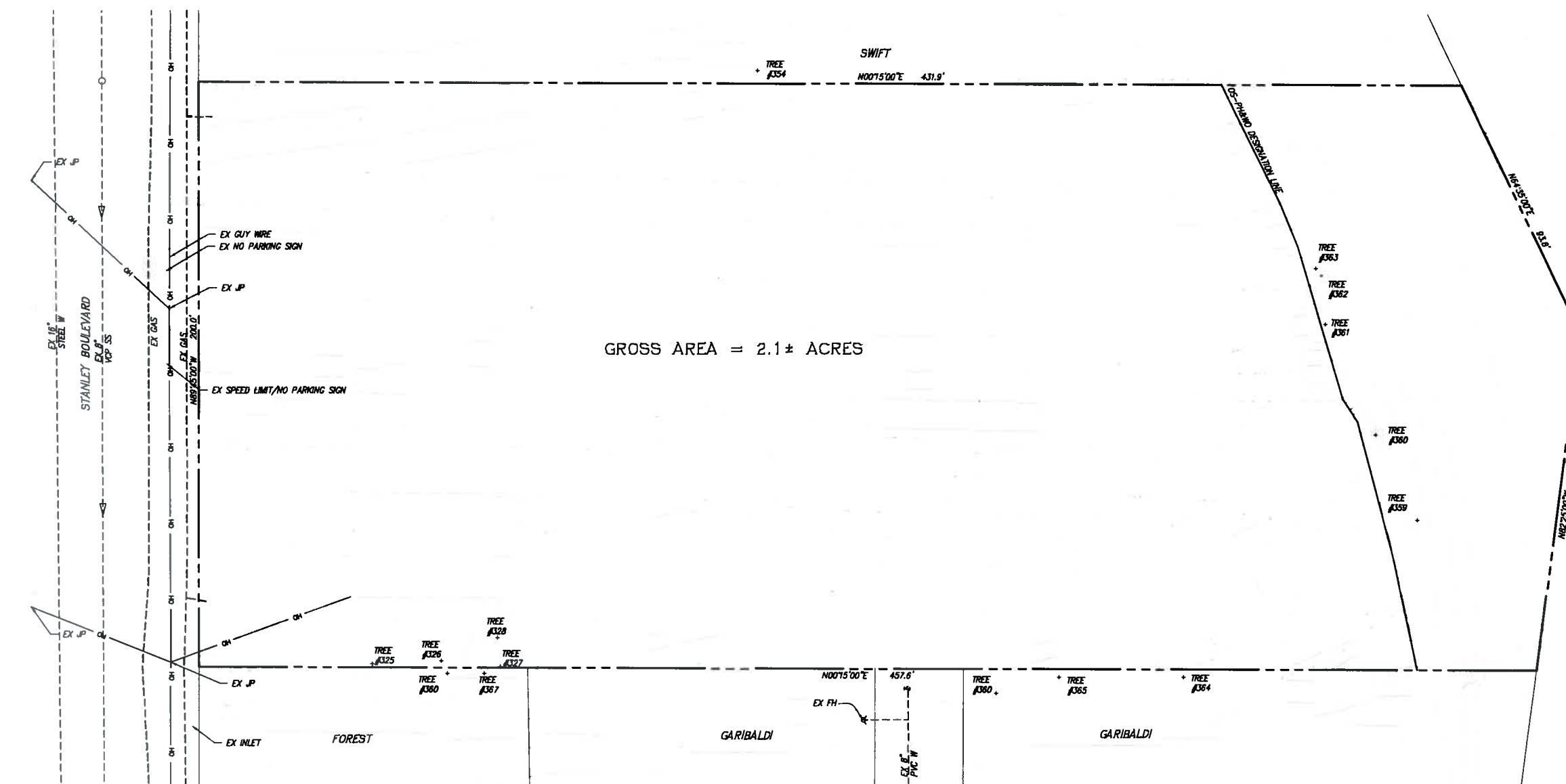

GROSS AREA = 2.1± ACRES

NOTE: ALL TREES TO BE REMOVED WITH THE EXCEPTION OF TREES # 354, 359-363, AND 364-368 PER HORTISCIENCE TREE REPORT DATED APRIL 2013. ALL TREES TO BE SAVED ARE SHOWN HEREON AND HAVE BEEN TAGGED IN THE FIELD. VERIFY TREE NUMBER TO TAG AND PROVIDE PROTECTION PER CITY OF PLEASANTON PRIOR TO BEGINNING DEMOLITION WORK.

EXISTING CONDITIONS
WAGNER PROPERTY
 CITY OF PLEASANTON, ALAMEDA COUNTY, CALIFORNIA

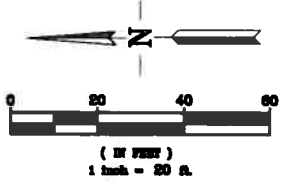

RJA
RUGGERI-JENSEN-AZAR
 ENGINEERS • PLANNERS • SURVEYORS
 4620 CHABOT DRIVE, SUITE 200 PLEASANTON, CA 94588
 PHONE: (925) 227-3700 FAX: (925) 227-9300

G:\2013\121001A\121001A.dwg 5/22/2013 12:07:30 PM 0104 S0414E



LEGEND:

	0 - 10%
	10% - 20%
	20%+

SLOPE CLASSIFICATION
WAGNER PROPERTY
 CITY OF PLEASANTON, ALAMEDA COUNTY, CALIFORNIA

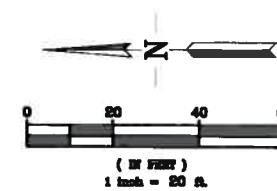

RJA
RUGGERI-JENSEN-AZAR
 ENGINEERS • PLANNERS • SURVEYORS
 4690 CHABOT DRIVE, SUITE 200, PLEASANTON, CA 94588
 PHONE: (925) 227-9100 FAX: (925) 227-9300

© (L2007) (1100) (01) (1001) PD-05.DWG 5/22/2013 12:12:08 PM FLOSA SAKAZI

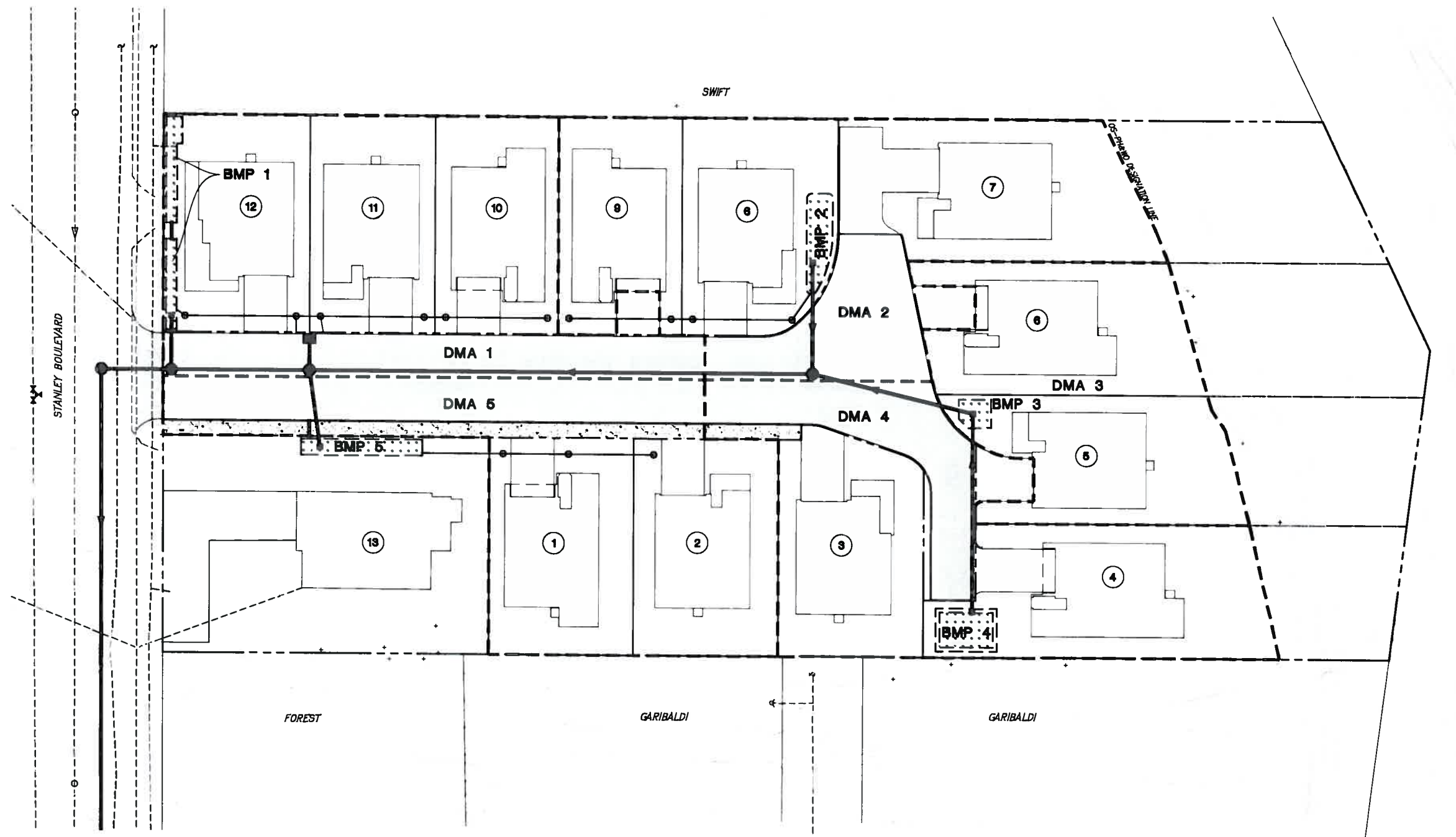

PRELIMINARY STORM WATER TREATMENT CALCULATIONS (COMBINATION METHOD)

AREA ID	AREA OF ASPHALT (SF)	AREA OF CONCRETE (SF)	AREA OF ROOF (SF)	AREA OF LANDSCAPE (SF)	EFFECTIVE AREA (SF)	BIORETENTION REQUIRED (SF)	BIORETENTION PROVIDED (SF)	BIORETENTION PROVIDED (SF)
						COMBINATION METHOD	(3% OF EFFECTIVE AREA)	
DMA1	3,296	1,214	5,178	5,769	10,265	273	308	312
DMA2	2,710	1,665	5,024	7,147	10,114	262	303	310
DMA3	0	0	3,391	5,569	3,948	90	118	120
DMA4	2,847	1,435	3,402	6,026	8,287	182	249	258
DMA5	3,228	1,823	3,391	4,716	8,914	229	267	270

NOTE: SIZING FACTORS BASED ON THE COMBINATION FLOW/VOLUME SIZING CRITERIA SET FORTH IN THE MAY 29, 2012 ALAMEDA COUNTY C.3 STORMWATER TECHNICAL GUIDANCE HANDBOOK. BIORETENTION AREAS HAVE BEEN ESTABLISHED BASED ON PENDING UPDATE TO ALAMEDA COUNTY C.3 GUIDEBOOK REQUIRING A SIZING MINIMUM OF 3% OF THE EFFECTIVE AREA.

STORMWATER TREATMENT PLAN WAGNER PROPERTY

CITY OF PLEASANTON, ALAMEDA COUNTY, CALIFORNIA

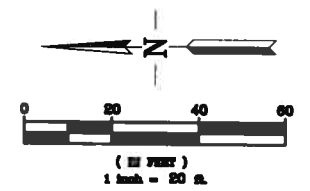

RJA
RUGGERI-JENSEN-AZAR
ENGINEERS • PLANNERS • SURVEYORS
4890 CHABOT DRIVE, SUITE 200, PLEASANTON, CA 94588
PHONE: (925) 227-9100 FAX: (925) 227-9300

C:\LAWRENCE\121001A\121001A_Plan\DWG\121001A_Plan.dwg 5/22/2013 1:03:09 PM EUSA SAKJLITE

LEGEND

- HERITAGE TREE
- NATIVE TREE
- TREES TO BE PRESERVED
- 366** TREE IN GOOD CONDITION
- 366** TREE IN POOR CONDITION

NOTES:
 1. TREE ASSESSMENT AND PRESERVATION RECOMMENDATIONS ARE TAKEN FROM THE TREE REPORT PREPARED BY HORTSCIENCE, MAY 2013. FOR PURPOSES OF THIS SUMMARY, TREES WITH A CONDITION RATINGS OF POOR AND FAIR (1, 2 OR 3) ARE CATEGORIZED AS POOR, AND TREES WITH A CONDITION RATING OF GOOD AND EXCELLENT (4 OR 5) ARE CATEGORIZED AS GOOD.
 2. TREES SHOWN AS NATIVE ARE THOSE FOUND TO BE NATIVE TO PLEASANTON.

TOTAL TREES 44
TREES TO BE PRESERVED 16

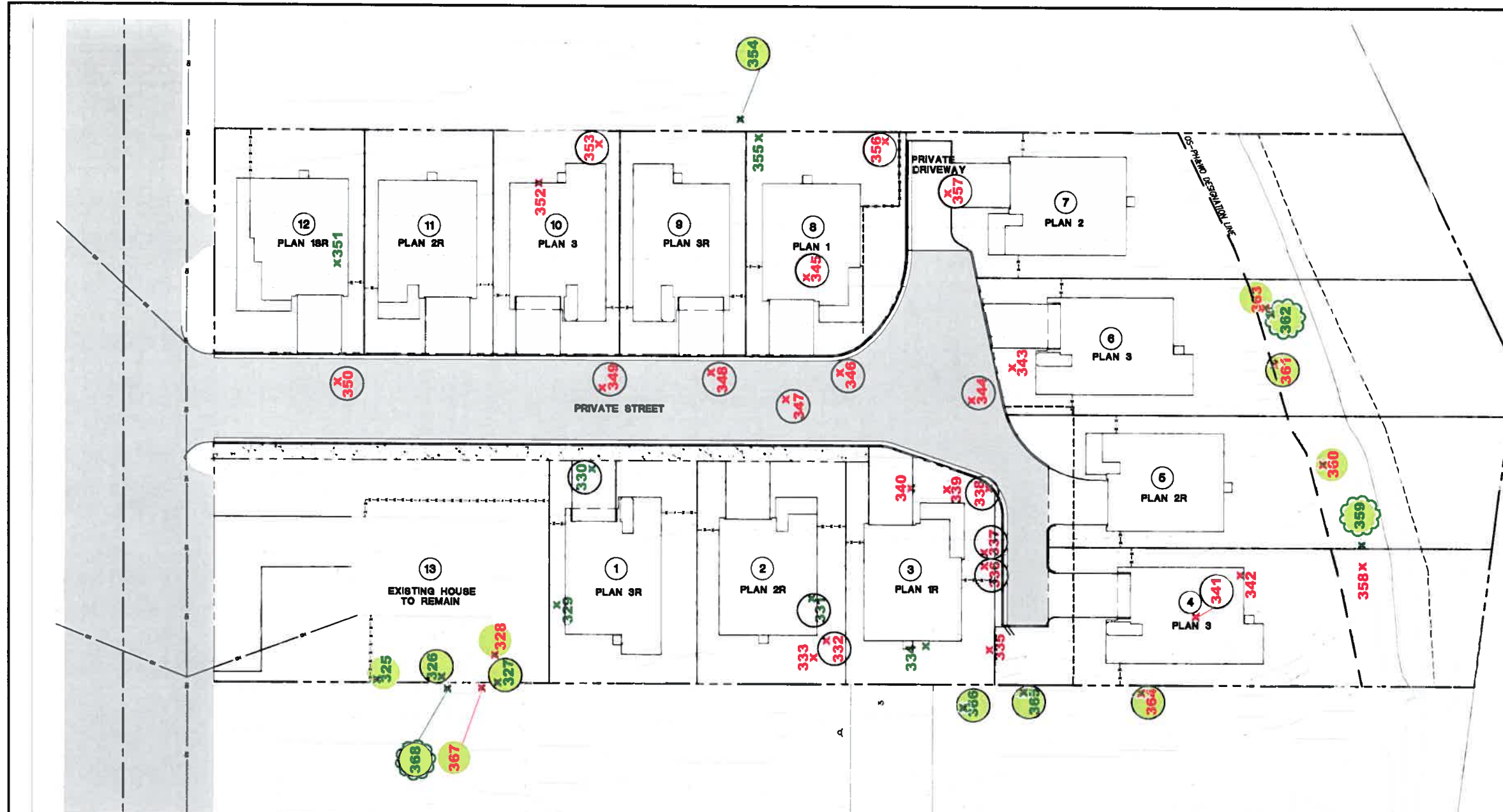
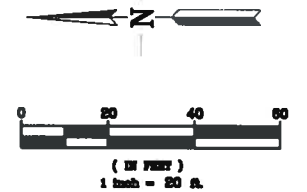

Tree No.	Species	Trunk Diameter (in.)	Heritage Tree?	Condition 1-poor	Recommended Action per Preservation Subtality	Location	Notes
325	Tree of heaven	10	No	4	Preserve	-	Existing house to remain
326	Tree of heaven	11, 10, 9	Yes	4	Preserve	-	Existing house to remain
327	Tree of heaven	17, 14, 13	Yes	4	Preserve	-	Existing house to remain
328	Japanese privet	8.5	No	3	Preserve	-	Existing house to remain
329	Tree of heaven	8	No	4	Remove	Lot 1	Within project area; impacts from construction
330	Cordylone	10, 10, 8, 6	Yes	4	Remove	Lot 1	Within project area; impacts from construction
331	Casary Island date palm	28	Yes	5	Remove	Lot 2	Within project area; impacts from construction
332	Modesto ash	28	Yes	3	Remove	Lot 2	Within project area; poor suitability for preservation
333	Cordylone	5.5, 3.3	No	3	Remove	Lot 2	Within project area; poor suitability for preservation
334	Japanese privet	7.2	No	4	Remove	Lot 3	Within project area; impacts from construction
335	Flowering plum	6.6, 5.4, 4.3	No	3	Remove	Lot 3	Within project area; poor suitability for preservation

Tree No.	Species	Trunk Diameter (in.)	Heritage Tree?	Condition 1-poor	Recommended Action per Preservation Subtality	Location	Notes
336	Paper mulberry	12, 8, 8	Yes	3	Remove	Lot 3	Within project area; poor suitability for preservation
337	Paper mulberry	14, 6	Yes	3	Remove	Lot 3	Within project area; poor suitability for preservation
338	Paper mulberry	8.9, 7.8, 6.5	Yes	2	Remove	Lot 3	Within project area; poor suitability for preservation
339	Paper mulberry	7, 8, 6	No	2	Remove	Lot 3	Within project area; poor suitability for preservation
340	Paper mulberry	7, 6.5, 4	No	1	Remove	Lot 3	Within project area; poor suitability for preservation
341	Blue gum	58	Yes	3	Remove	Lot 4	Within project area; poor suitability for preservation
342	Japanese privet	5, 4	No	3	Remove	Lot 4	Within project area; poor suitability for preservation
343	Japanese privet	6.5, 4, 4	No	3	Remove	Lot 6	Within project area; poor suitability for preservation
344	Paper mulberry	17, 10, 7	Yes	3	Remove	Street	Within project area; poor suitability for preservation
345	Modesto ash	25	Yes	1	Remove	Lot 8	Within project area; poor suitability for preservation
346	Moroney pine	30	Yes	3	Remove	Street	Within project area; poor suitability for preservation

Tree No.	Species	Trunk Diameter (in.)	Heritage Tree?	Condition 1-poor	Recommended Action per Preservation Subtality	Location	Notes
347	Modesto ash	25	Yes	2	Remove	Street	Within project area; poor suitability for preservation
348	Modesto ash	23	Yes	2	Remove	Street	Within project area; poor suitability for preservation
349	Modesto ash	25	Yes	3	Remove	Street	Within project area; impacts from construction
350	English oak	48	Yes	2	Remove	Street	Within project area; poor suitability for preservation
351	Modesto ash	17	No	4	Remove	Lot 12	Within project area; impacts from construction
352	Japanese privet	7, 6.5	No	3	Remove	Lot 10	Within project area; poor suitability for preservation
353	Modesto ash	31	Yes	3	Remove	Lot 10	Within project area; impacts from construction
354	Panacea walnut	38	Yes	4	Preserve	Off-site, near lot 9	Near property line; prune to provide clearance for construction
355	Japanese privet	4.3	No	4	Remove	Lot 8	Within project area; impacts from construction
356	Modesto ash	28	Yes	3	Remove	Lot 8	Within project area; poor suitability for preservation
357	Japanese privet	10, 8, 6	Yes	3	Remove	Lot 7	Within project area; poor suitability for preservation

Tree No.	Species	Trunk Diameter (in.)	Heritage Tree?	Condition 1-poor	Recommended Action per Preservation Subtality	Location	Notes
358	Tree of heaven	11, 10	Yes	3	Remove	Creek	Poor suitability for preservation
359	Western sycamore	42, 30, 20	Yes	4	Preserve	Creek	
360	Calli black walnut	13	No	3	Preserve	Creek	
361	Modesto ash	11, 10	Yes	3	Preserve	Creek	
362	Valley oak	7	No	4	Preserve	Creek	
363	Calli black walnut	8, 4	No	3	Preserve	Creek	
364	Sherton elm	28, 7	Yes	2	Preserve	Off-site, near lot 4	Near property line; prune to provide clearance for construction
365	Calli incense cedar	28, 7	Yes	5	Preserve	Off-site, near lot 3	Near property line; prune to provide clearance for construction
366	Decider cedar	30, 7	Yes	5	Preserve	Off-site, near lot 3	Near property line; prune to provide clearance for construction
367	Flowering plum	7, 6.6, 5.5	No	3	Preserve	Off-site near existing house	Near property line; prune to provide clearance for construction
368	Coast live oak	10, 8, 7, 6	Yes	4	Preserve	Off-site, near existing house	Near property line; prune to provide clearance for construction

EXISTING TREES - WAGNER PROPERTY
PONDEROSA HOMES
 CITY OF PLEASANTON, ALAMEDA COUNTY, CALIFORNIA

RJA
RUGGERI-JENSEN-AZAR
 ENGINEERS • PLANNERS • SURVEYORS
 4690 CHABOT DRIVE, SUITE 200, PLEASANTON, CA 94588
 PHONE: (925) 227-9100 FAX: (925) 227-9300



NOTE - Artist conception; colors, materials and application may vary.

© 2013 WILLIAM HEZMALHALCH ARCHITECTS, INC.

Plan 1S - Craftsman
Lot 12 - Scheme 6

Plan 2AR - Cottage
Lot 11 - Scheme 3

Plan 3B - Craftsman
Lot 10 - Scheme 5

Plan 3AR - Cottage
Lot 9 - Scheme 1

Plan 1B - Craftsman
Lot 8 - Scheme 5

Conceptual Streetscene

WAGNER SITE
Pleasanton, California
Ponderosa Homes



WH
WILLIAM HEZMALHALCH
ARCHITECTS INC.
5000 EXECUTIVE PARKWAY SUITE 315 SAN RAMON CA 94583-4210
925 463 1700 fax 949 250 1529
2850 REDHILL AVENUE SUITE 200 SANTA ANA CA 92705-5543
949 250 0607 www.wharchitects.com fax 949 250 1529

Revised May 22, 2013

December 18, 2012

SS

2012032 - Wagner Site - Pleasanton, CA

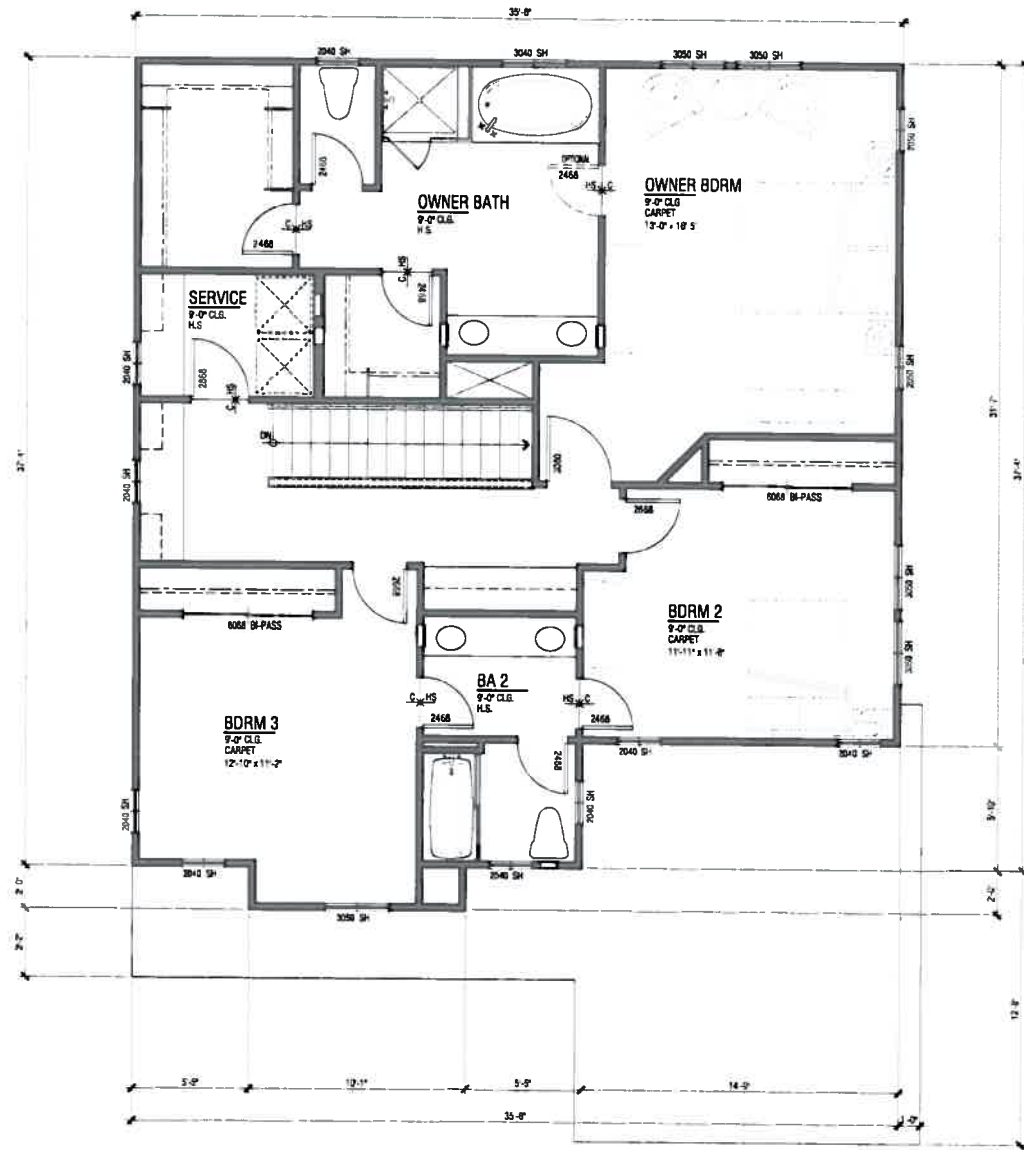

Upper Floor - 1,256 SF

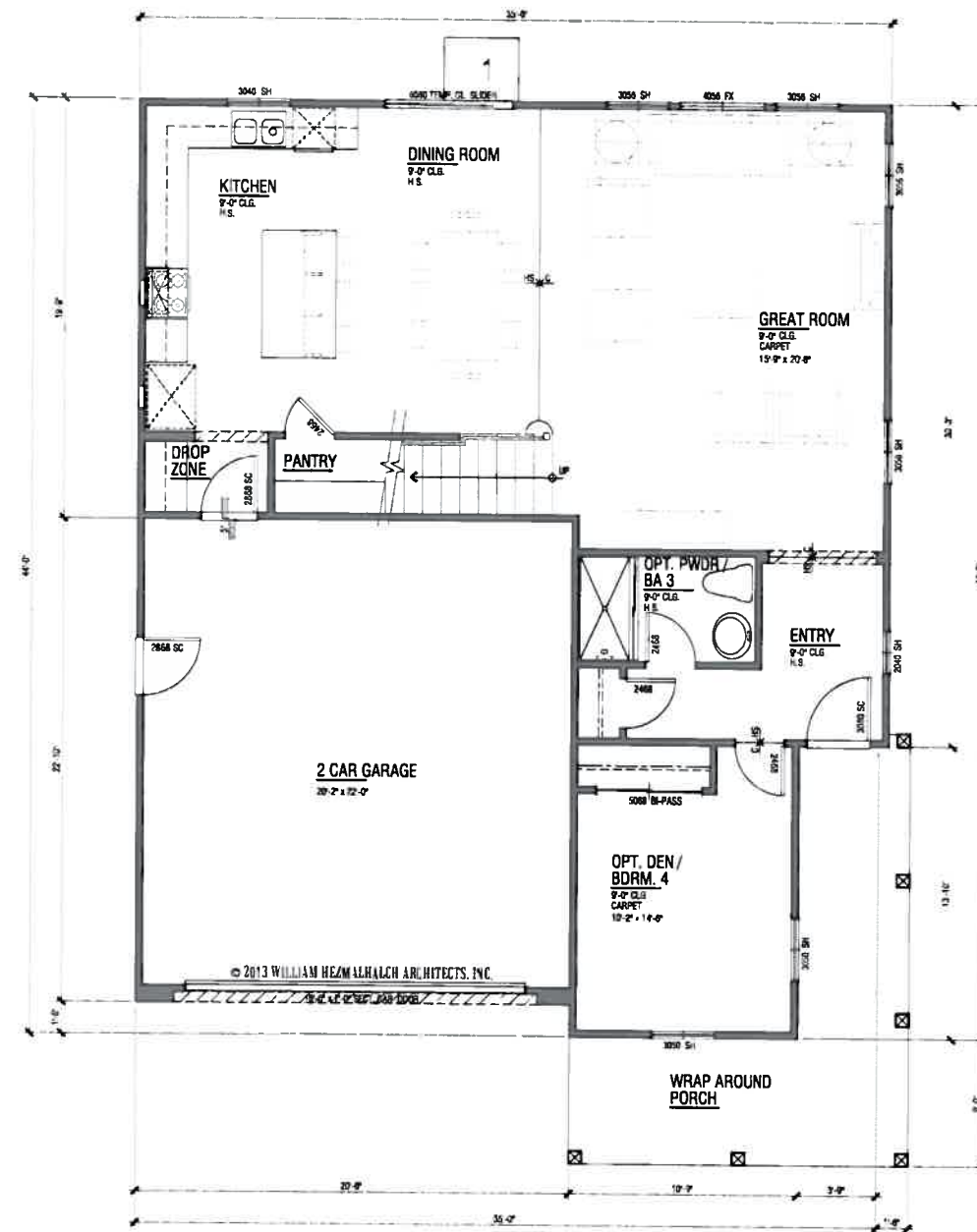

Lower Floor - 1005 SF

Plan 1

2,261 SF
4 Bdrm/3 Ba
2 Car Garage

WAGNER SITE

Pleasanton, California
Ponderosa Homes



W
WILLIAM HEZMALHALCH ARCHITECTS INC.
 5000 EXECUTIVE PARKWAY SUITE 375 SAN RAMON CA 94583-4210
 925 463 1700 fax 949 250 1529
 2850 REDHILL AVENUE SUITE 200 SANTA ANA CA 92705-5543
 949 250 0607 www.wharchitects.com fax 949 250 1529

Revised May 22, 2013
December 18, 2012

1.1

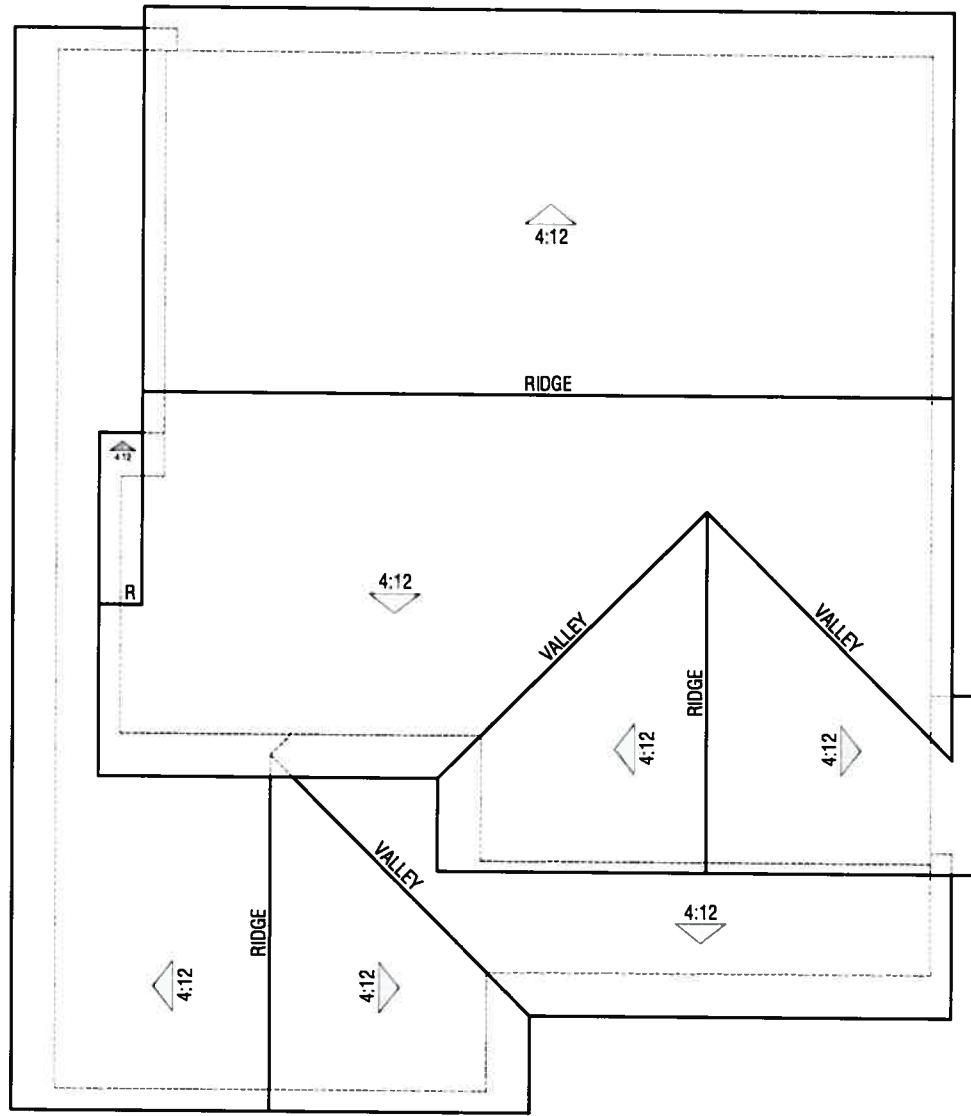

Plan 1S - Elevation 'B' - Craftsman

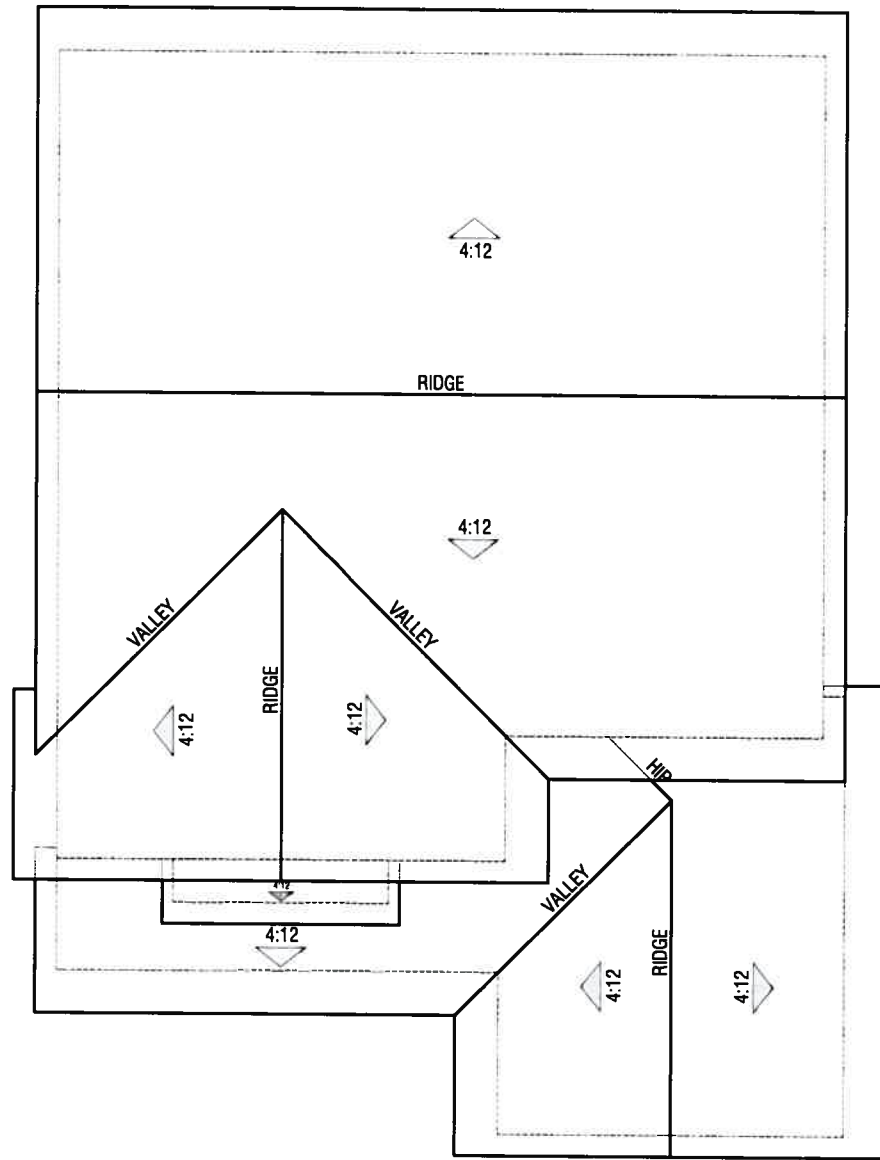

Elevation 'B' - Craftsman

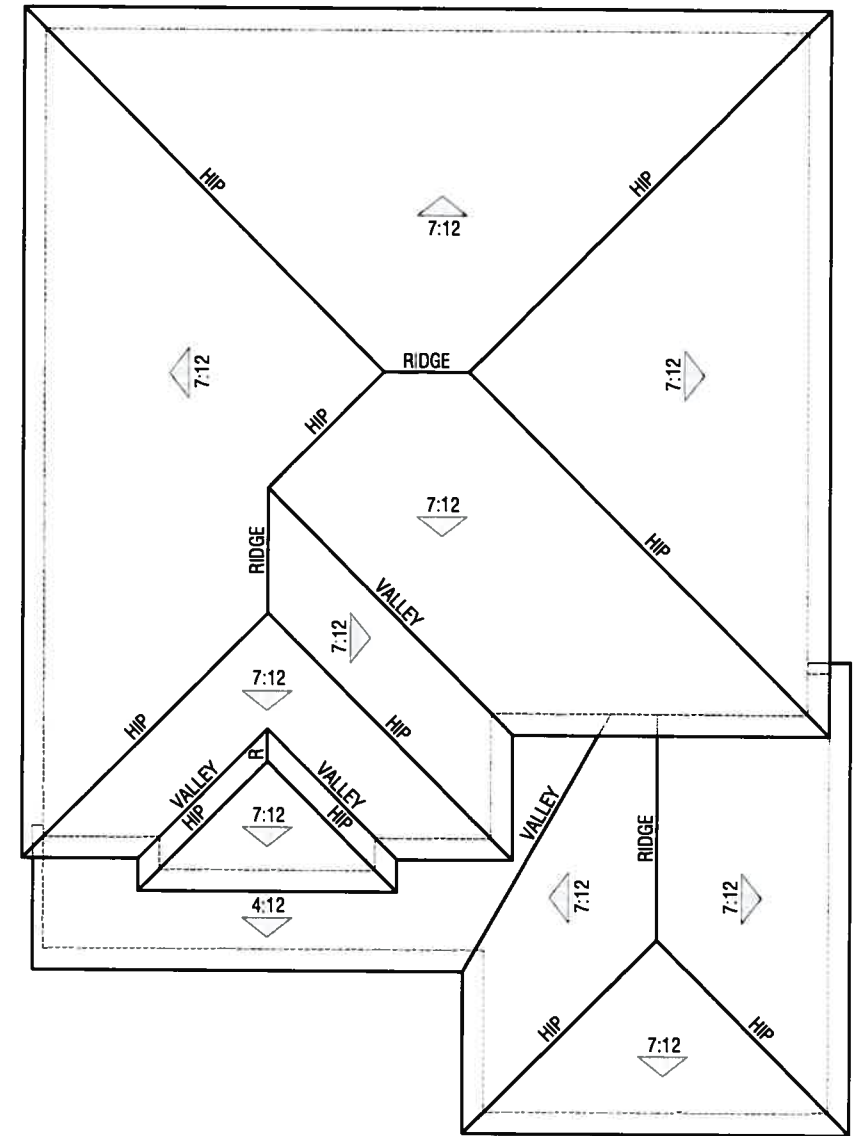

Elevation 'A' - Cottage

Plan 1

2,261 SF
4 Bdrm/3 Ba
2 Car Garage

WAGNER SITE
Pleasanton, California
Ponderosa Homes



WH
WILLIAM HEZMALHALCH
ARCHITECTS INC
5000 EXECUTIVE PARKWAY SUITE 375 SAN RAMON CA 94583-4211
925 463 1700 fax 949 250 1529
2850 REDHILL AVENUE SUITE 200 SANTA ANA CA 92715-6543
949 250 0607 www.wharchitects.com fax 949 250 1529

Revised May 22, 2013
December 18, 2012

1.2



NOTE - Artist conception; colors, materials and application may vary



© 2013 WILLIAM HEZMALHALCH ARCHITECTS, INC.

Elevation 'B' - Craftsman: Color Scheme 5

- ROOF: COMPOSITION SHINGLE ROOF
- FASCIA: 2 x 6 BARGE BOARD & WOOD OUTLOOKER
- GABLE: HORIZONTAL LAP SIDING
- WALL: STUCCO & HORIZONTAL LAP SIDING
- TRIM: STUCCO OVER FOAM TRIM PER ARCHITECTURAL STYLE
- WINDOW: VINYL WINDOW FRAMES WITH MULLION
- ACCENTS: WOOD COLUMN WITH MANUFACTURED STONE VENEER BASE
PREFABRICATED SHUTTERS AND ENTRY DOOR ACCENT COLOR
- GARAGE DOOR: METAL SECTIONAL ROLL-UP GARAGE DOOR PER ARCHITECTURAL
STYLE, WITH GLASS LITES

Plan 1

2,261 SF
4 Bdrm/3 Ba
2 Car Garage

WAGNER SITE
Pleasanton, California
Ponderosa Homes

Elevation 'A' - Cottage: Color Scheme 2

- ROOF: COMPOSITION SHINGLE ROOF
- FASCIA: 2 x 6 BARGE BOARD
- WALL: STUCCO
- TRIM: STUCCO OVER FOAM TRIM PER ARCHITECTURAL STYLE
- WINDOW: VINYL WINDOW FRAMES WITH MULLION
- ACCENTS: WOOD COLUMN WITH SHAPED BRACE AND WOOD RAILING AT PORCH
PREFABRICATED SHUTTERS AND ENTRY DOOR ACCENT COLOR
DECORATIVE METAL POTSHelves
- GARAGE DOOR: METAL SECTIONAL ROLL-UP GARAGE DOOR PER ARCHITECTURAL
STYLE, WITH GLASS LITES



© 2013 WILLIAM HEZMALHALCH ARCHITECTS, INC.

Revised May 22, 2013

December 18, 2012

1.3

WH
WILLIAM HEZMALHALCH
ARCHITECTS, INC.
5000 EXECUTIVE PARKWAY SUITE 311 SAN RAMON CA 94583-4211
925 483 1700 fax 949 250 529
2850 REDHILL AVENUE SUITE 200 SANTA ANA CA 92705-6543
949 250 0607 www.wharchitects.com fax 949 250 529

2012032 - Wagner Site - Pleasanton, CA

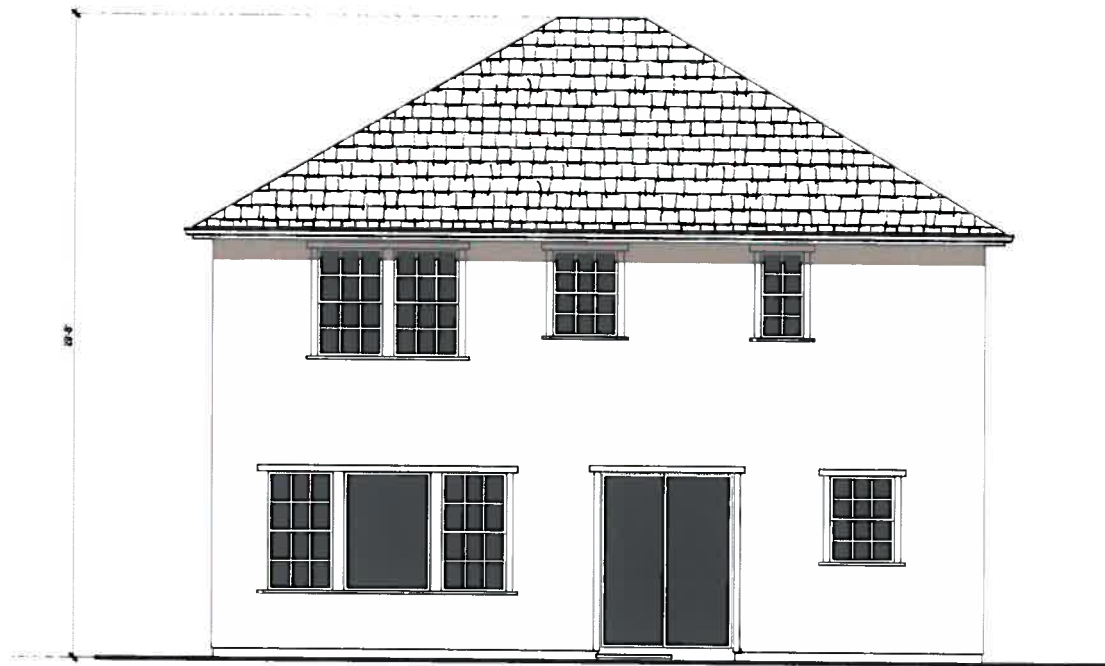

Rear Elevation

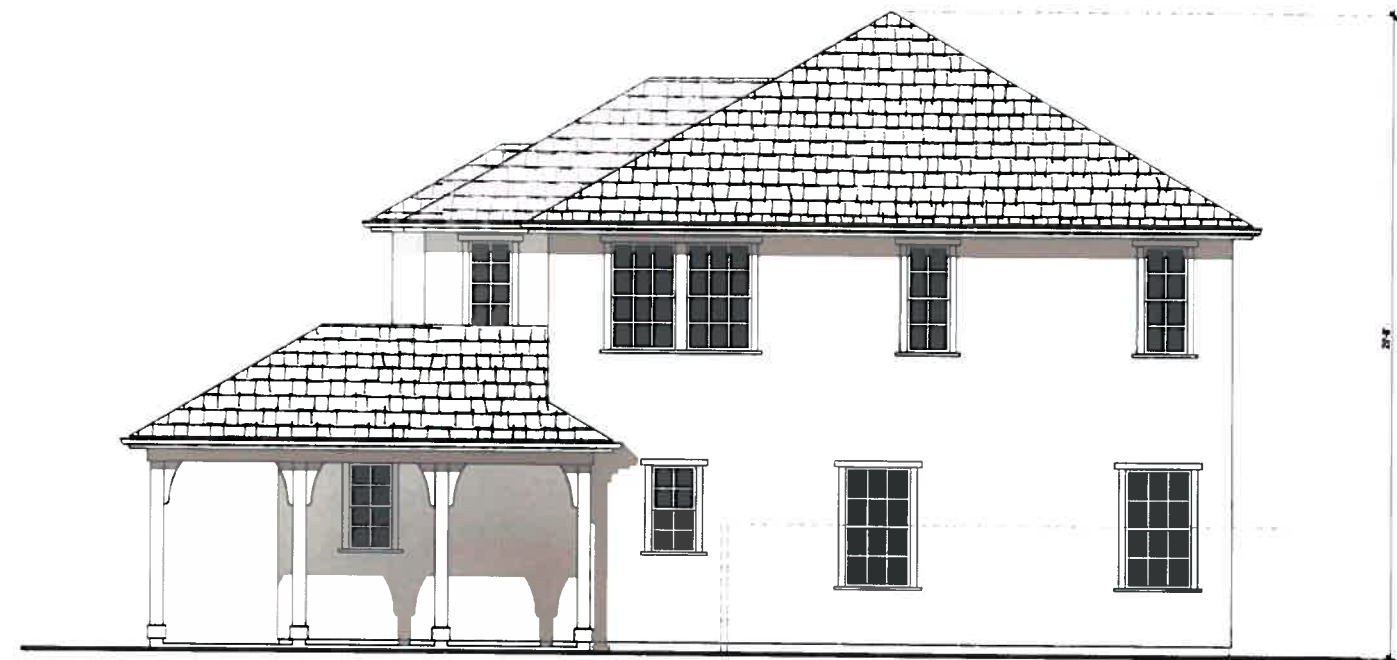

Right Elevation

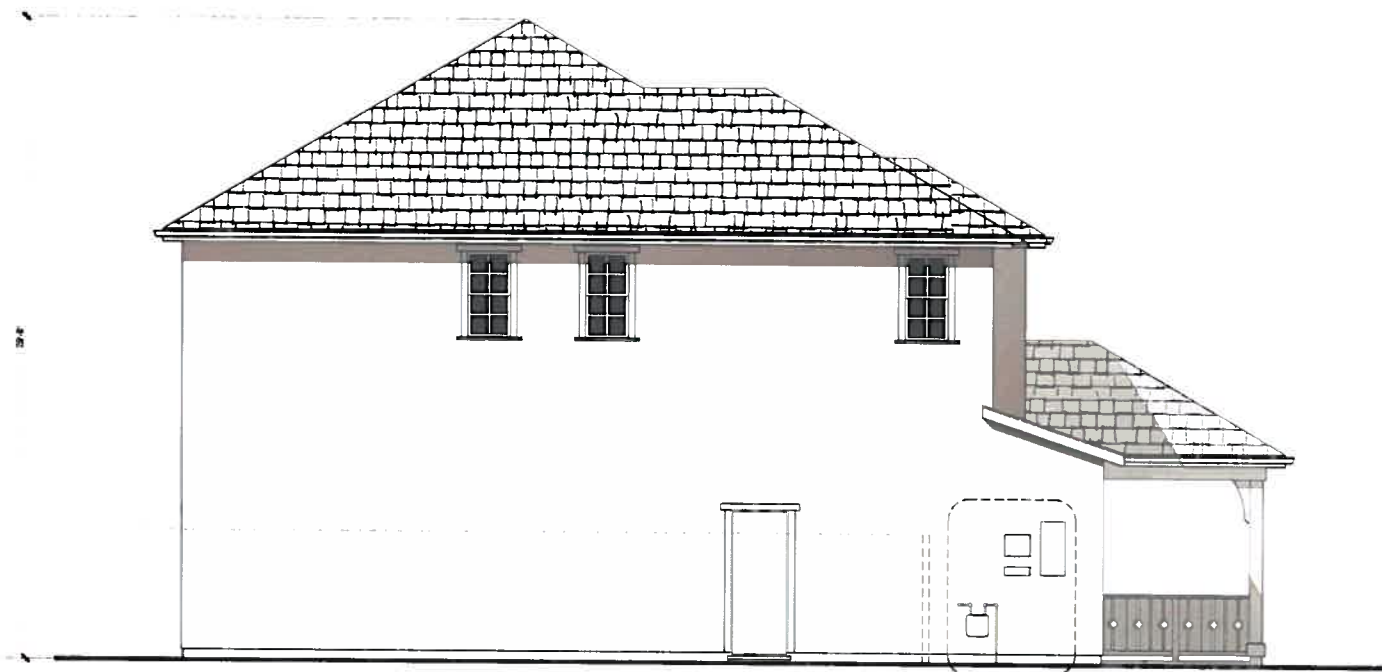

Left Elevation



Front Elevation

© 2012 WILLIAM HEZMALHALCH ARCHITECTS, INC.

Plan 1
Elevation 'A'

WAGNER SITE
Pleasanton, California
Ponderosa Homes

- ROOF: COMPOSITION SHINGLE ROOF
- FASCIA: 2 x 6 BARGE BOARD
- WALL: STUCCO
- TRIM: STUCCO OVER FOAM TRIM PER ARCHITECTURAL STYLE
- WINDOW: VINYL WINDOW FRAMES WITH MULLION
- ACCENTS: WOOD COLUMN WITH SHAPED BRACE AND WOOD RAILING AT PORCH
PREFABRICATED SHUTTERS AND ENTRY DOOR ACCENT COLOR
DECORATIVE METAL POTSHelves
- GARAGE DOOR: METAL SECTIONAL ROLL-UP GARAGE DOOR PER ARCHITECTURAL
STYLE, WITH GLASS LITES



© 2012 WILLIAM HEZMALHALCH ARCHITECTS, INC.

Revised May 22, 2013

December 18, 2012

1.4

WH
WILLIAM HEZMALHALCH
ARCHITECTS INC.
5000 EXECUTIVE PARKWAY SUITE 315 SAN RAMON CA 94583-4210
925 463 1700 fax 949 250 1529
2850 REDHILL AVENUE SUITE 200 SANTA ANA CA 92705-6543
949 250 0607 www.wharchitects.com fax 949 250 1529

2012032 - Wagner Site - Pleasanton, CA



Rear Elevation



Right Elevation

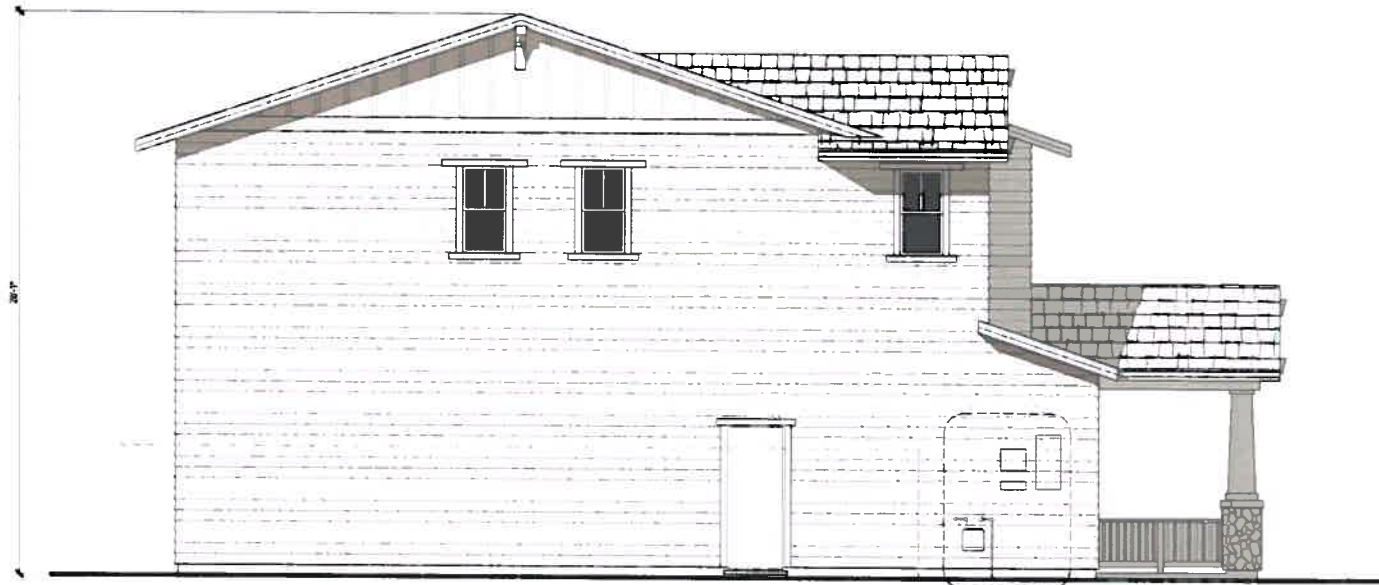

Left Elevation

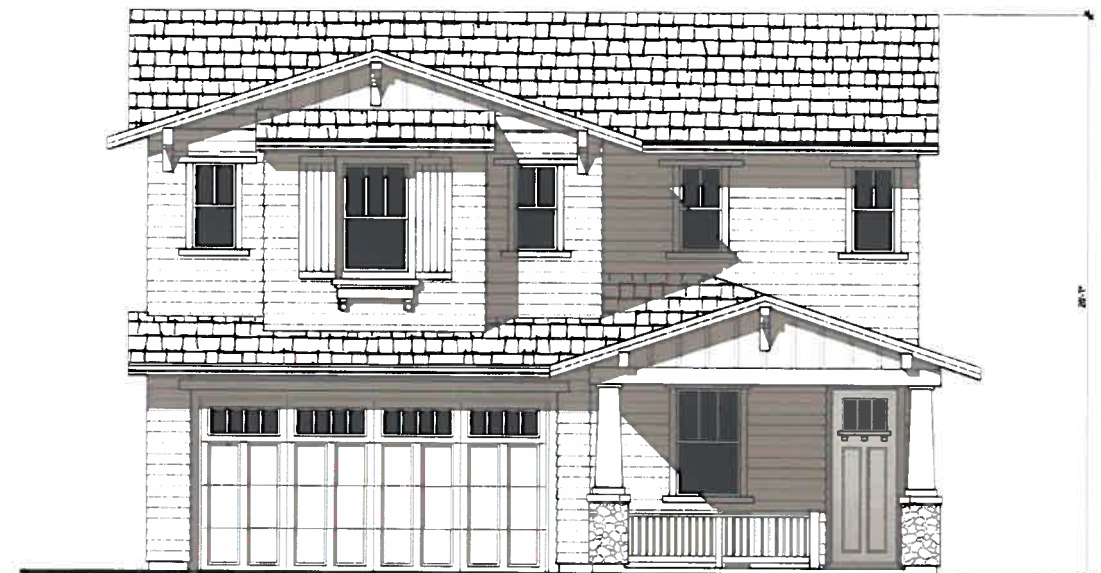

Front Elevation

Plan 1
Elevation 'B'

WAGNER SITE
Pleasanton, California
Ponderosa Homes

- ROOF: COMPOSITION SHINGLE ROOF
- FASCIA: 2 x 6 BARGE BOARD & WOOD OUTLOOKER
- GABLE: HORIZONTAL LAP SIDING
- WALL: STUCCO & HORIZONTAL LAP SIDING
- TRIM: STUCCO OVER FOAM TRIM PER ARCHITECTURAL STYLE
- WINDOW: VINYL WINDOW FRAMES WITH MULLION
- ACCENTS: WOOD COLUMN WITH MANUFACTURED STONE VENEER BASE
PREFABRICATED SHUTTERS AND ENTRY DOOR ACCENT COLOR
- GARAGE DOOR: METAL SECTIONAL ROLL-UP GARAGE DOOR PER ARCHITECTURAL
STYLE, WITH GLASS LITES

0 4 8 12

© 2012 WILLIAM HEZMALHALCH ARCHITECTS, INC.

© 2013 WILLIAM HEZMALHALCH ARCHITECTS, INC.

WH
WILLIAM HEZMALHALCH
ARCHITECTS INC.
5000 EXECUTIVE PARKWAY SUITE 175 SAN RAMON CA 94583-4211
925 483 1700 fax 949 250 1529
2850 REDHILL AVENUE SUITE 200 SANTA ANA CA 92705-6543
949 250 0607 www.wharchitects.com fax 949 250 1529

Revised May 22, 2013

December 18, 2012

1.5

2012032 - Wagner Site - Pleasanton, CA

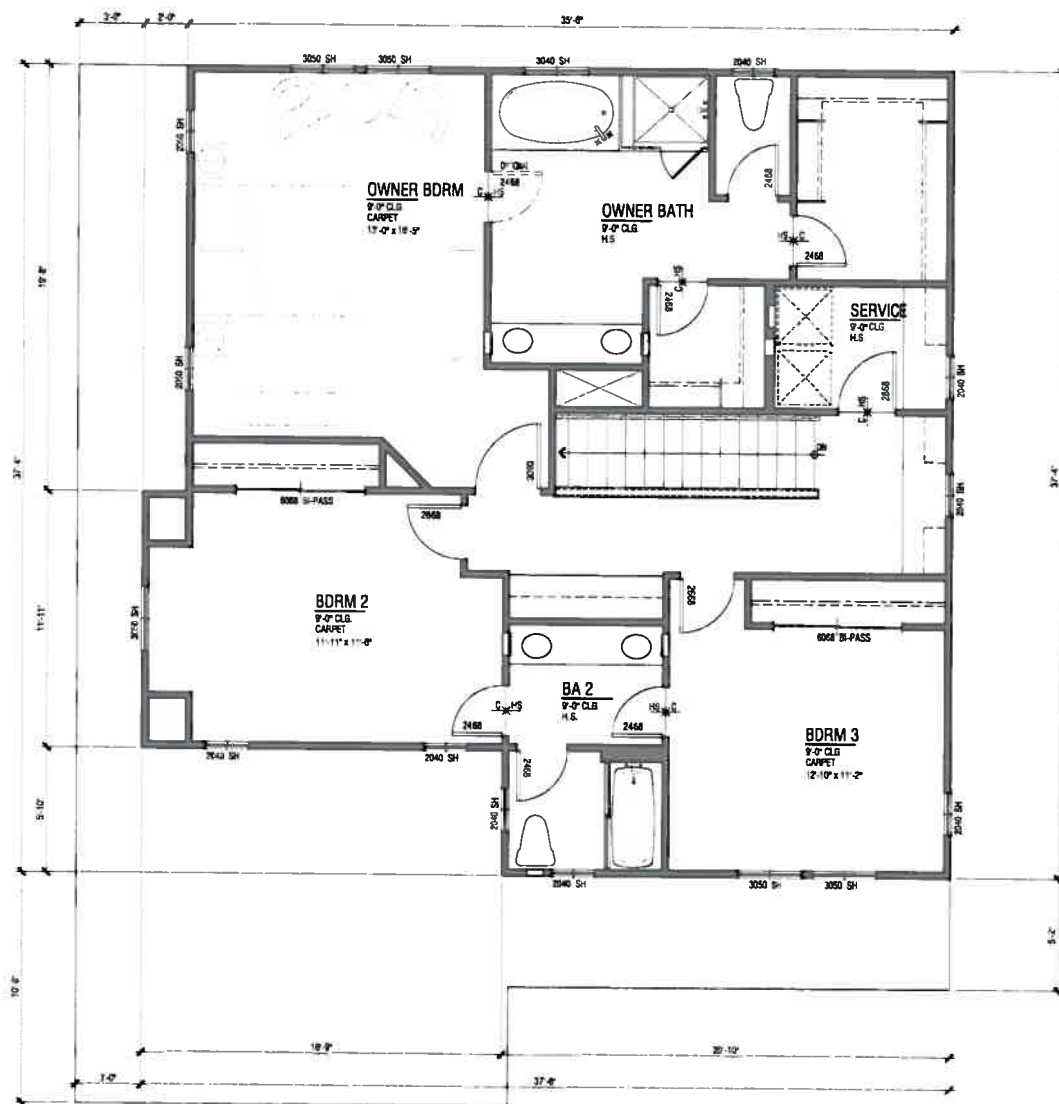

Upper Floor - 1,205 SF

Plan 1-S

2,197 SF
4 Bdrm/3 Ba
2 Car Garage

WAGNER SITE
Pleasanton, California
Ponderosa Homes

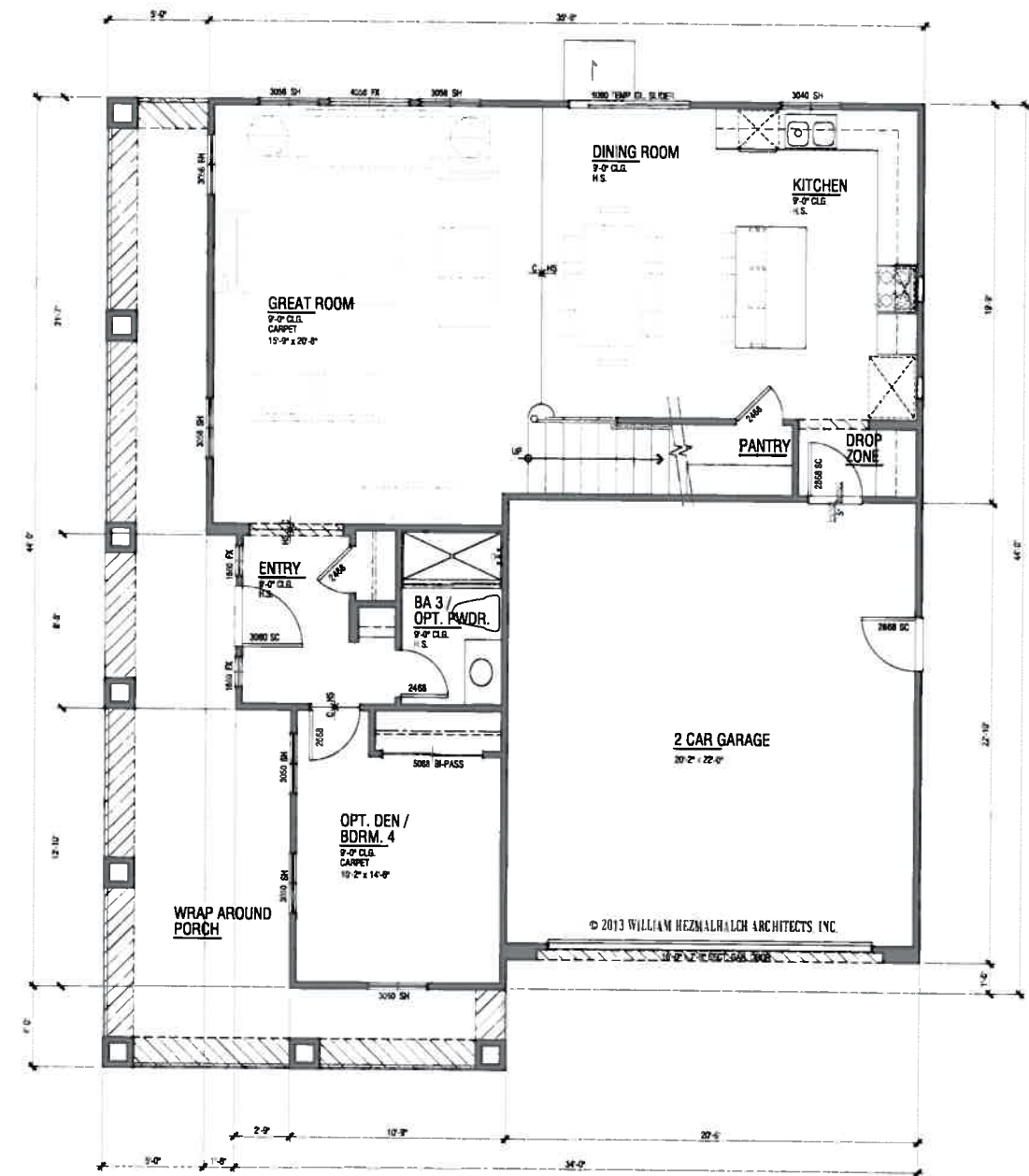

Lower Floor - 992 SF



W
WILLIAM HEZMALHALCH ARCHITECTS INC.
5000 EXECUTIVE PARKWAY SUITE 375 SAN RAMON CA 94583-4211
925 463 1700 fax 949 250 1529
2850 REDHILL AVENUE SUITE 200 SANTA ANA CA 92705-5643
949 250 0607 www.whearchitects.com fax 949 250 1529

Revised May 22, 2013
December 18, 2012

1.6

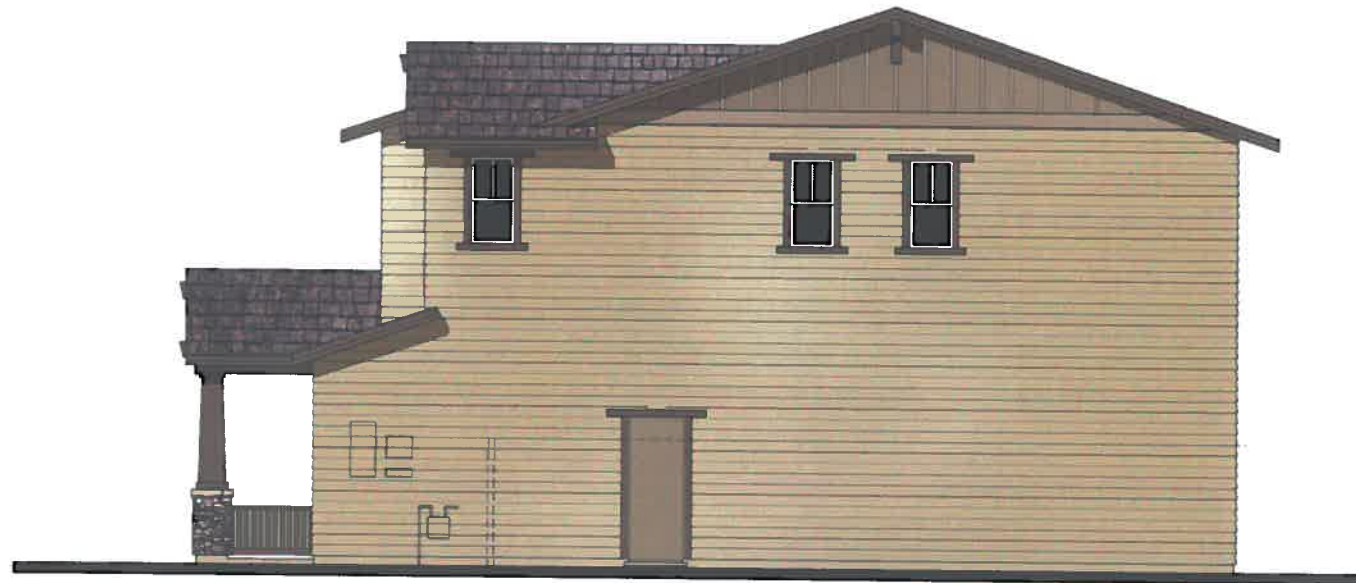

Right Elevation 'B' - Craftsman



Rear Elevation 'B' - Craftsman



Entry Elevation 'B' - Craftsman



Front Elevation 'B' - Craftsman: Color Scheme 6

NOTE - Artist on exception, colors, materials and application may vary

Plan 1-S

2,197 SF
4 Bdrm/3 Ba
2 Car Garage
Lot 12

WAGNER SITE
Pleasanton, California
Ponderosa Homes

ROOF: COMPOSITION SHINGLE ROOF
FASCIA: 2 x 6 BARGE BOARD & WOOD OUTLOOKER
GABLE: HORIZONTAL LAP SIDING
WALL: STUCCO & HORIZONTAL LAP SIDING
TRIM: STUCCO OVER FOAM TRIM PER ARCHITECTURAL STYLE
WINDOW: VINYL WINDOW FRAMES WITH MULLION
ACCENTS: WOOD COLUMN WITH MANUFACTURED STONE VENEER BASE
GARAGE DOOR: PREFABRICATED SHUTTERS AND ENTRY DOOR ACCENT COLOR METAL SECTIONAL ROLL-UP GARAGE DOOR PER ARCHITECTURAL STYLE, WITH GLASS LITES



© 2012 WILLIAM HEZMALHALCH ARCHITECTS, INC.

© 2013 WILLIAM HEZMALHALCH ARCHITECTS, INC.

Revised May 22, 2013

December 18, 2012

1.7

WH
WILLIAM HEZMALHALCH
ARCHITECTS, INC.
5000 EXECUTIVE PARKWAY, SUITE 375 SAN RAMON, CA 94583-4210
925 483 1700 fax 949 250 1529
2650 REDHILL AVENUE, SUITE 200 SANTA ANA, CA 92705-6543
949 250 0807 www.wharchitects.com fax 949 250 1529

2012032 - Wagner Site - Pleasanton, CA

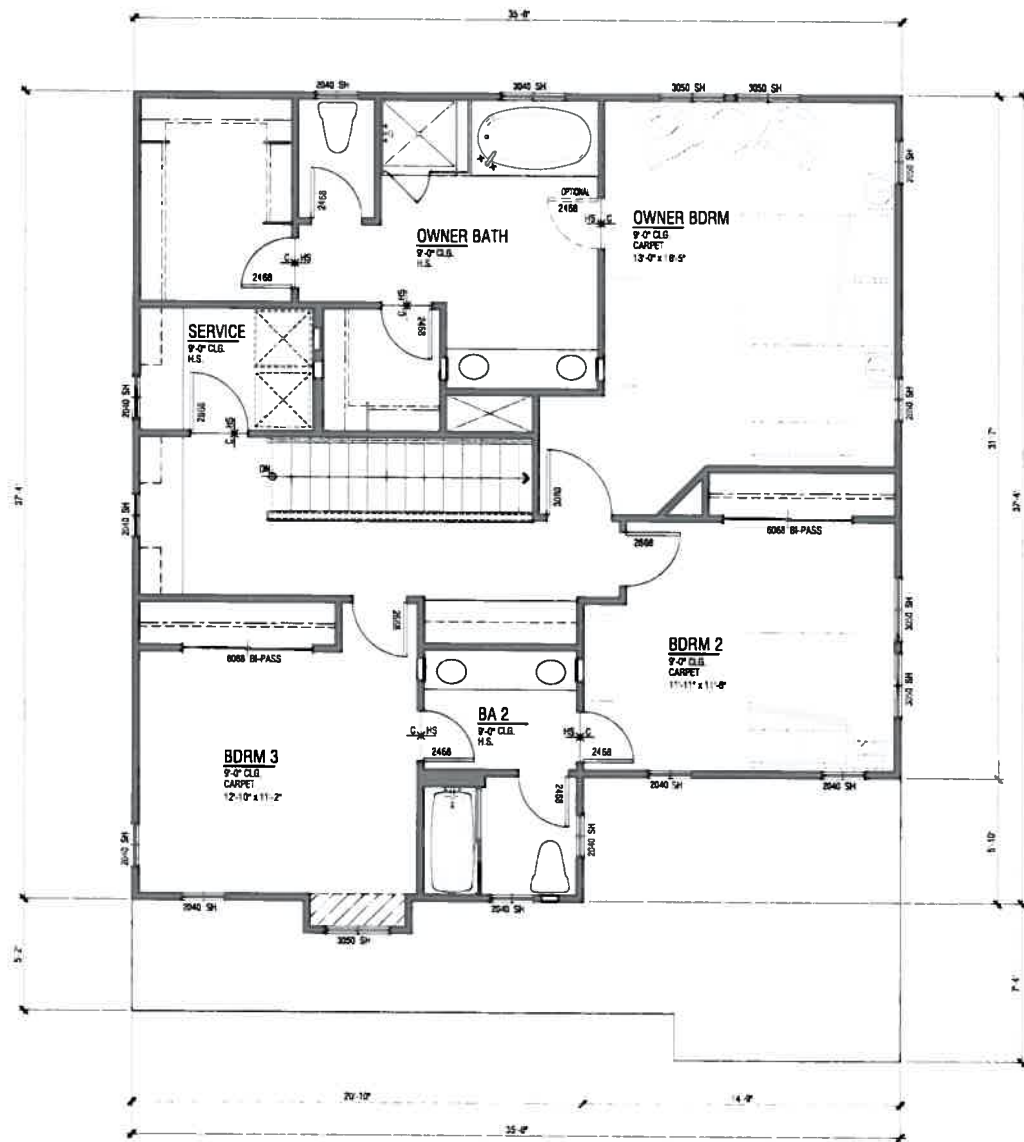

Upper Floor - 1,190 SF

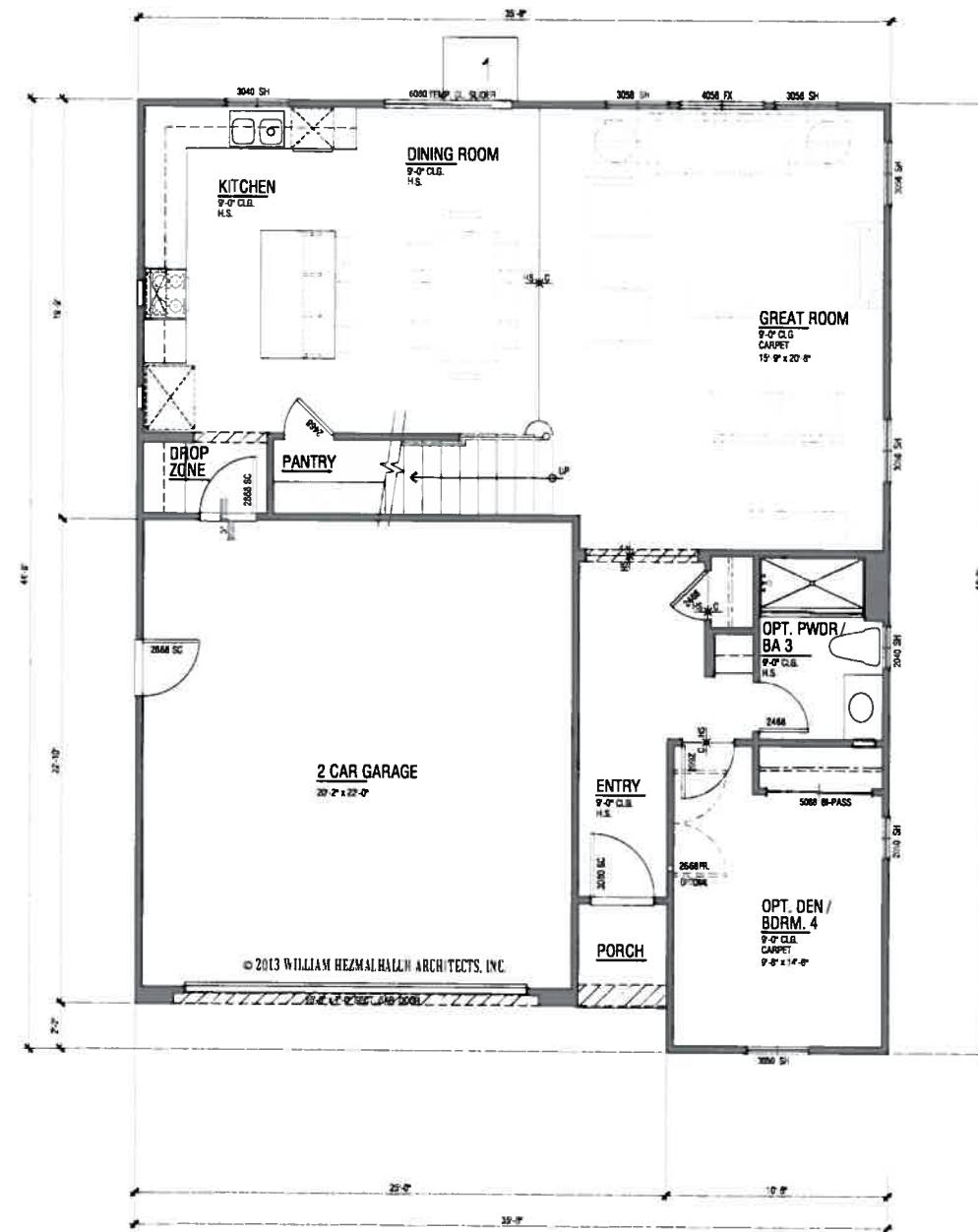

Lower Floor - 1,036 SF

Plan 2

2,226 SF
4 Bdrm/3 Ba
2 Car Garage

WAGNER SITE
Pleasanton, California
Ponderosa Homes



Revised May 22, 2013

December 18, 2012

2.1



WILLIAM HEZMALHALCH ARCHITECTS INC.
5000 EXECUTIVE PARKWAY SUITE 315 SAN RAMON CA 94583-4211
925 483 1700 fax 949 250 1529
2850 REDHILL AVENUE SUITE 200 SANTA ANA CA 92705-5543
949 250 0507 www.aharchitects.com fax 949 250 1529

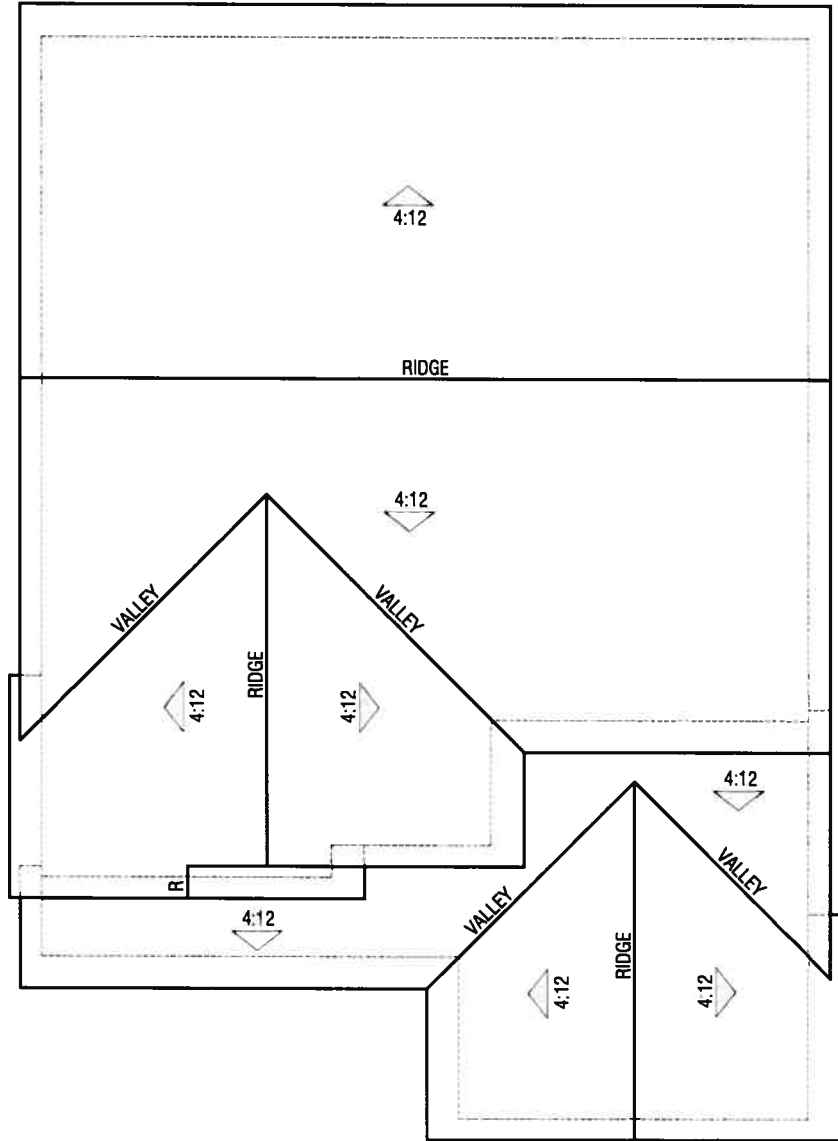

Elevation 'B' - Craftsman

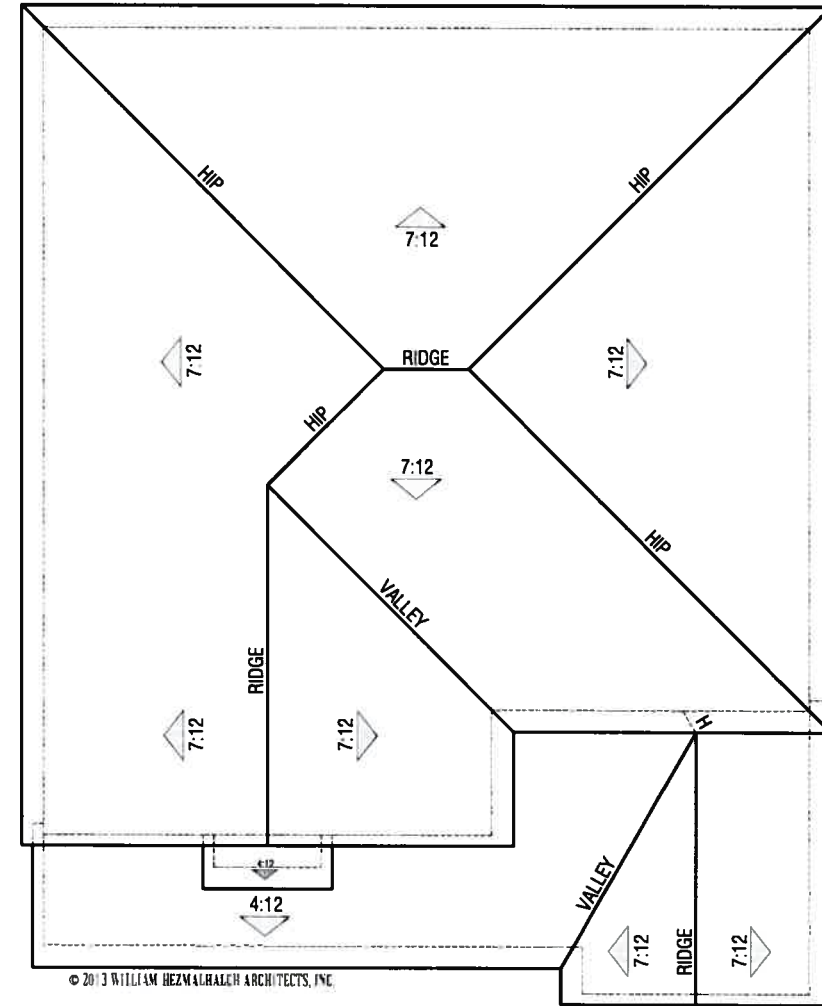

Elevation 'A' - Cottage

Plan 2

2,226 SF
4 Bdrm/3 Ba
2 Car Garage

WAGNER SITE
Pleasanton, California
Ponderosa Homes



WILLIAM HEZMALHALCH ARCHITECTS, INC.
5000 EXECUTIVE PARKWAY SUITE 375 SAN RAMON CA 94583-4210
925 463 1700 fax 949 250 1529
2850 REDHILL AVENUE SUITE 200 SANTA ANA CA 92705-6543
949 250 0607 www.wharchitects.com fax 949 250 1529

Revised May 22, 2013

December 18, 2012

2.2



NOTE - Artist conception; colors, materials and application may vary.



© 2013 WILLIAM HEZMALHALCH ARCHITECTS, INC.

Elevation 'B' - Craftsman: Color Scheme 4

ROOF: COMPOSITION SHINGLE ROOF
FASCIA: 2 x 6 BARGE BOARD & WOOD OUTLOOKER
GABLE: HORIZONTAL LAP SIDING
WALL: STUCCO & HORIZONTAL LAP SIDING
TRIM: STUCCO OVER FOAM TRIM PER ARCHITECTURAL STYLE
WINDOW: VINYL WINDOW FRAMES WITH MULLION
ACCENTS: WOOD COLUMN WITH MANUFACTURED STONE VENEER BASE
 ENTRY DOOR ACCENT COLOR
GARAGE DOOR: METAL SECTIONAL ROLL-UP GARAGE DOOR PER ARCHITECTURAL
 STYLE, WITH GLASS LITES

Plan 2

2,188 SF
 4 Bdrm/3 Ba
 2 Car Garage

WAGNER SITE
 Pleasanton, California
Ponderosa Homes

Elevation 'A' - Cottage: Color Scheme 3

ROOF: COMPOSITION SHINGLE ROOF
FASCIA: 2 x 6 BARGE BOARD
GABLE: LOUVERED VENT WITH TRIM
WALL: STUCCO
TRIM: STUCCO OVER FOAM TRIM PER ARCHITECTURAL STYLE
WINDOW: VINYL WINDOW FRAMES WITH MULLION
ACCENTS: WOOD COLUMN WITH SHAPED BRACE
 PREFABRICATED SHUTTERS AND ENTRY DOOR ACCENT COLOR
STONE: MANUFACTURED STONE VENEER
GARAGE DOOR: METAL SECTIONAL ROLL-UP GARAGE DOOR PER ARCHITECTURAL
 STYLE, WITH GLASS LITES



© 2013 WILLIAM HEZMALHALCH ARCHITECTS, INC.

Revised May 22, 2013

December 18, 2012

2.3

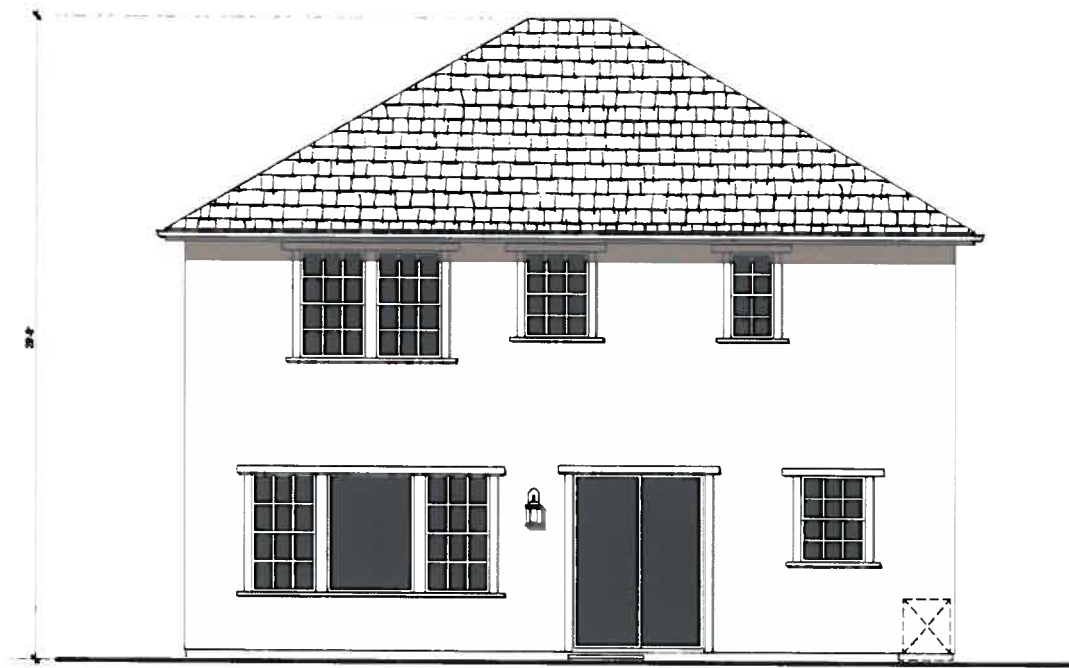

WILLIAM HEZMALHALCH
ARCHITECTS INC.
 5000 EXECUTIVE PARKWAY SUITE 375 SAN RAMON CA 94583-4211
 925 463 1700 fax 949 250 1529
 2850 REDHILL AVENUE SUITE 200 SANTA ANA CA 92705-5543
 949 250 0607 www.wharchitects.com fax 949 250 1529

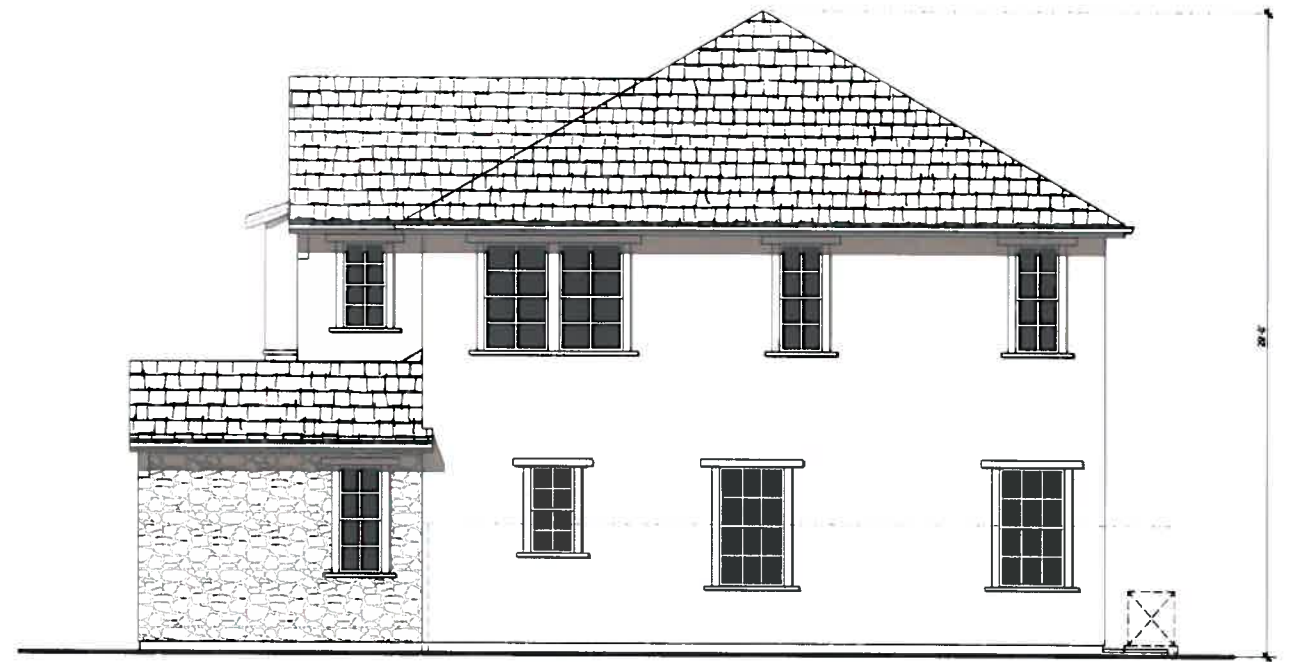

Rear Elevation

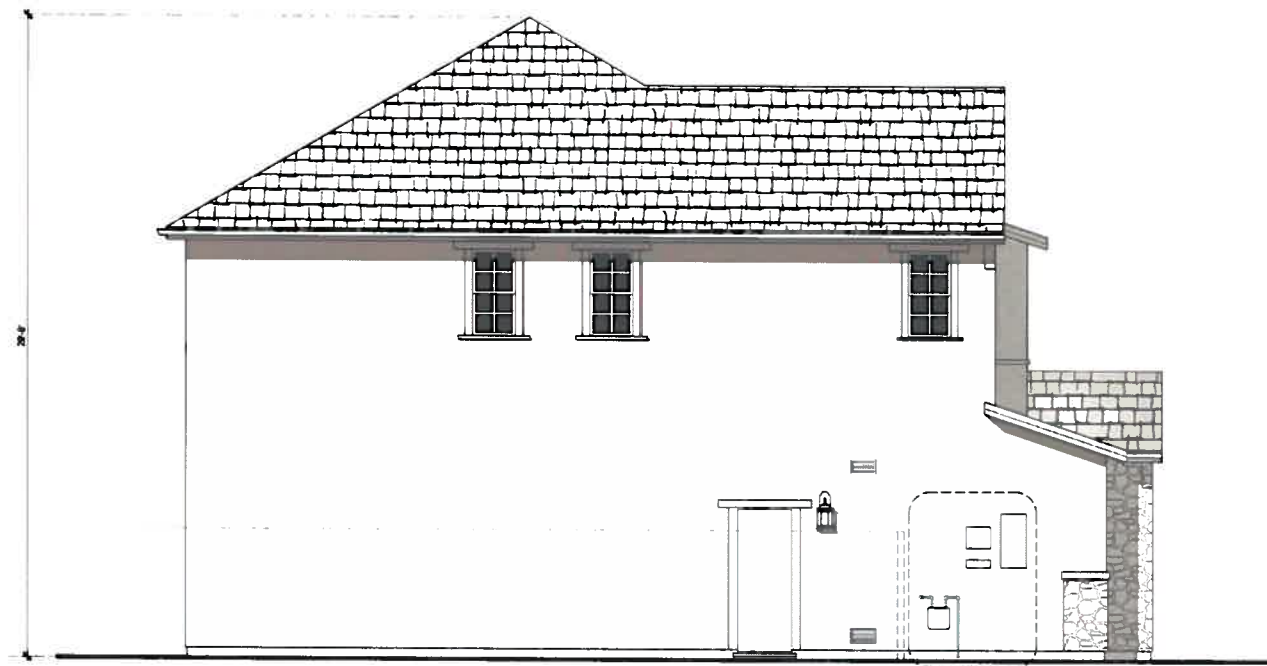

Right Elevation



Left Elevation

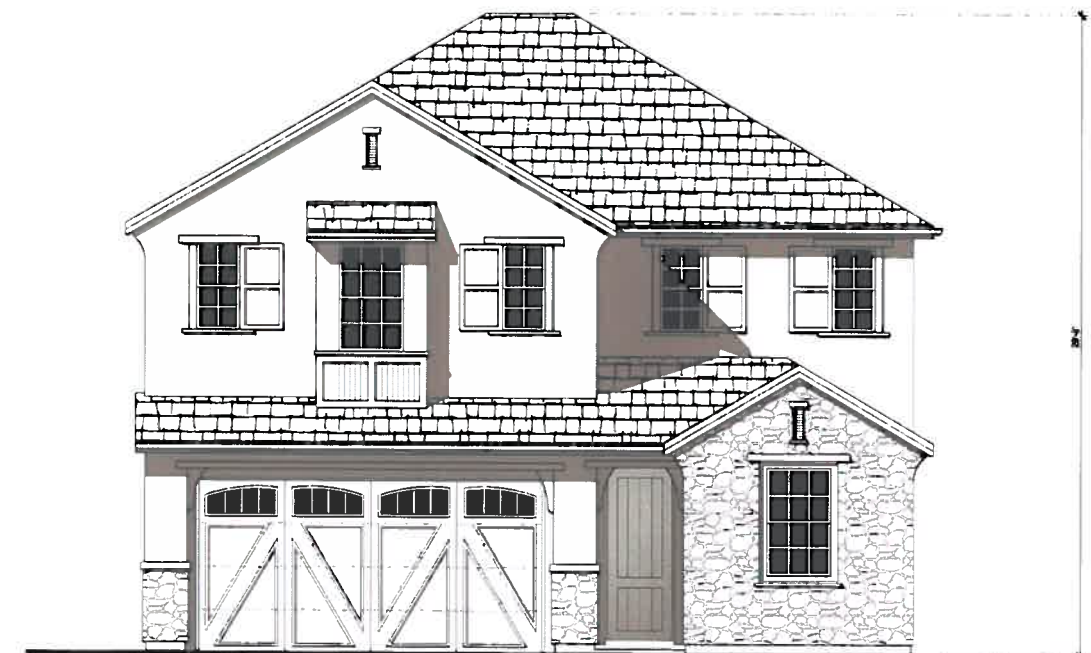

Front Elevation

© 2013 WILLIAM HEZMALHALCH ARCHITECTS, INC.

Plan 2
Elevation 'A'

WAGNER SITE
Pleasanton, California
Ponderosa Homes

- ROOF: COMPOSITION SHINGLE ROOF
- FASCIA: 2 x 6 BARGE BOARD
- GABLE: LOUVERED VENT WITH TRIM
- WALL: STUCCO
- TRIM: STUCCO OVER FOAM TRIM PER ARCHITECTURAL STYLE
- WINDOW: VINYL WINDOW FRAMES WITH MULLION
- ACCENTS: WOOD COLUMN WITH SHAPED BRACE
- STONE: MANUFACTURED STONE VENEER
- GARAGE DOOR: METAL SECTIONAL ROLL-UP GARAGE DOOR PER ARCHITECTURAL STYLE, WITH GLASS LITES



© 2013 WILLIAM HEZMALHALCH ARCHITECTS, INC.



WILLIAM HEZMALHALCH ARCHITECTS, INC.
500 EXECUTIVE PARKWAY, SUITE 375 SAN RAMON, CA 94583-4210
925 463 1700 fax 949 250 1529
2850 REDHILL AVENUE, SUITE 200 SANTA ANA, CA 92705-5543
949 250 0607 www.wharchitects.com fax 949 250 1529

Revised May 22, 2013

December 18, 2012

2.4



Rear Elevation



Right Elevation



Left Elevation

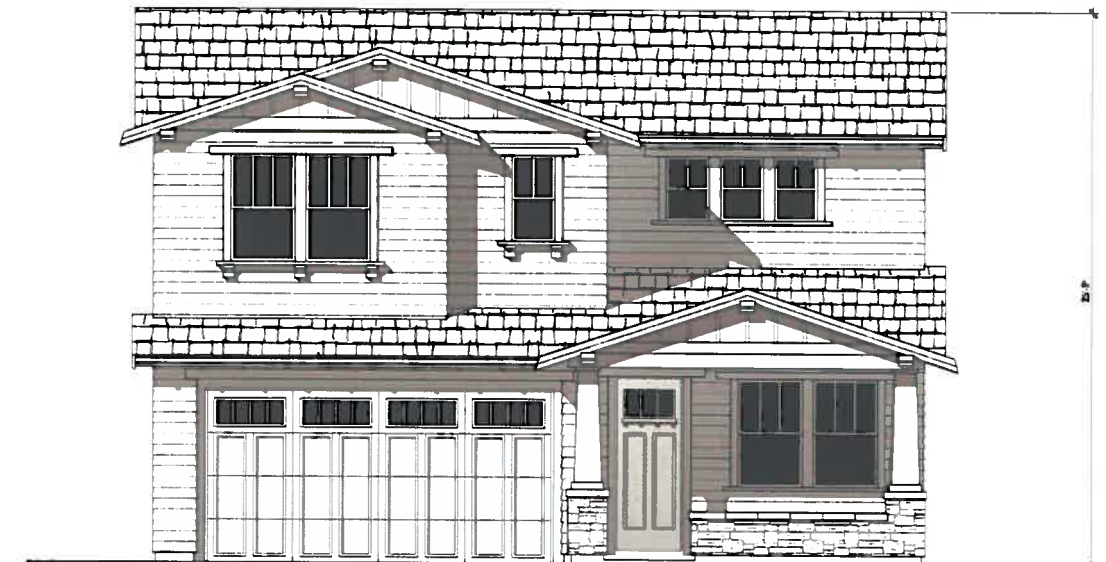

Front Elevation

© 2013 WILLIAM HEZMALHALCH ARCHITECTS, INC.

Plan 2
Elevation 'B'

WAGNER SITE
Pleasanton, California
Ponderosa Homes

- ROOF: COMPOSITION SHINGLE ROOF
- FASCIA: 2 x 6 BARGE BOARD & WOOD OUTLOOKER
- GABLE: HORIZONTAL LAP SIDING
- WALL: STUCCO & HORIZONTAL LAP SIDING
- TRIM: STUCCO OVER FOAM TRIM PER ARCHITECTURAL STYLE
- WINDOW: VINYL WINDOW FRAMES WITH MULLION
- ACCENTS: WOOD COLUMN WITH MANUFACTURED STONE VENEER BASE
- GARAGE DOOR: METAL SECTIONAL ROLL-UP GARAGE DOOR PER ARCHITECTURAL STYLE, WITH GLASS LITES



© 2012 WILLIAM HEZMALHALCH ARCHITECTS, INC.

Revised May 22, 2013

December 18, 2012

2.5

WH
WILLIAM HEZMALHALCH
ARCHITECTS, INC.
5000 EXECUTIVE PARKWAY SUITE 375 SAN RAMON CA 94583-4211
925 463 1700 fax 949 250 1529
2850 REDHILL AVENUE SUITE 200 SANTA ANA CA 92705-5543
949 250 0607 www.wharchitects.com fax 949 250 1529

2012032 - Wagner Site - Pleasanton, CA

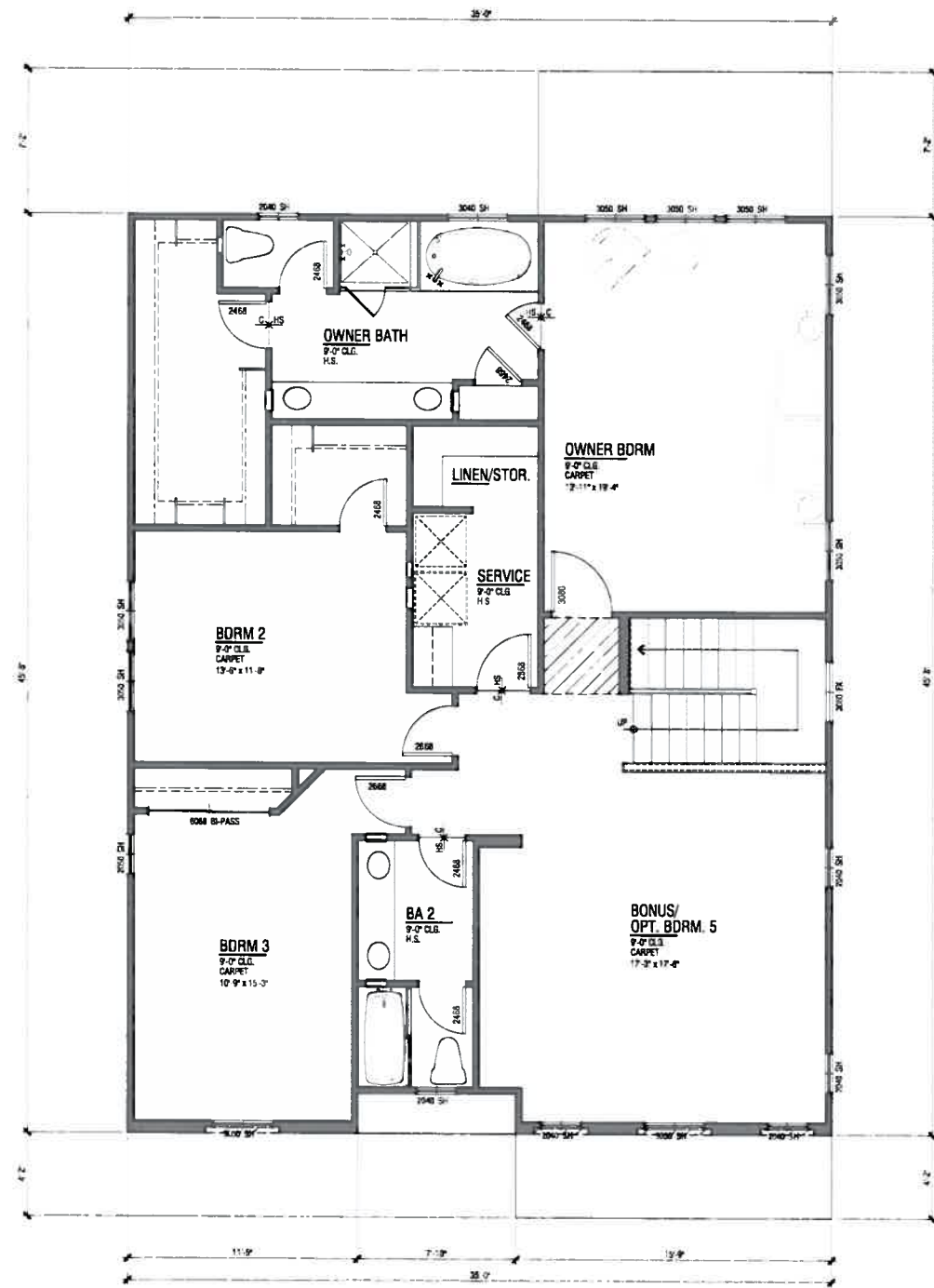

Upper Floor - 1,476 SF



© 2012 W. H. HEZMALHALCH ARCHITECTS, INC.

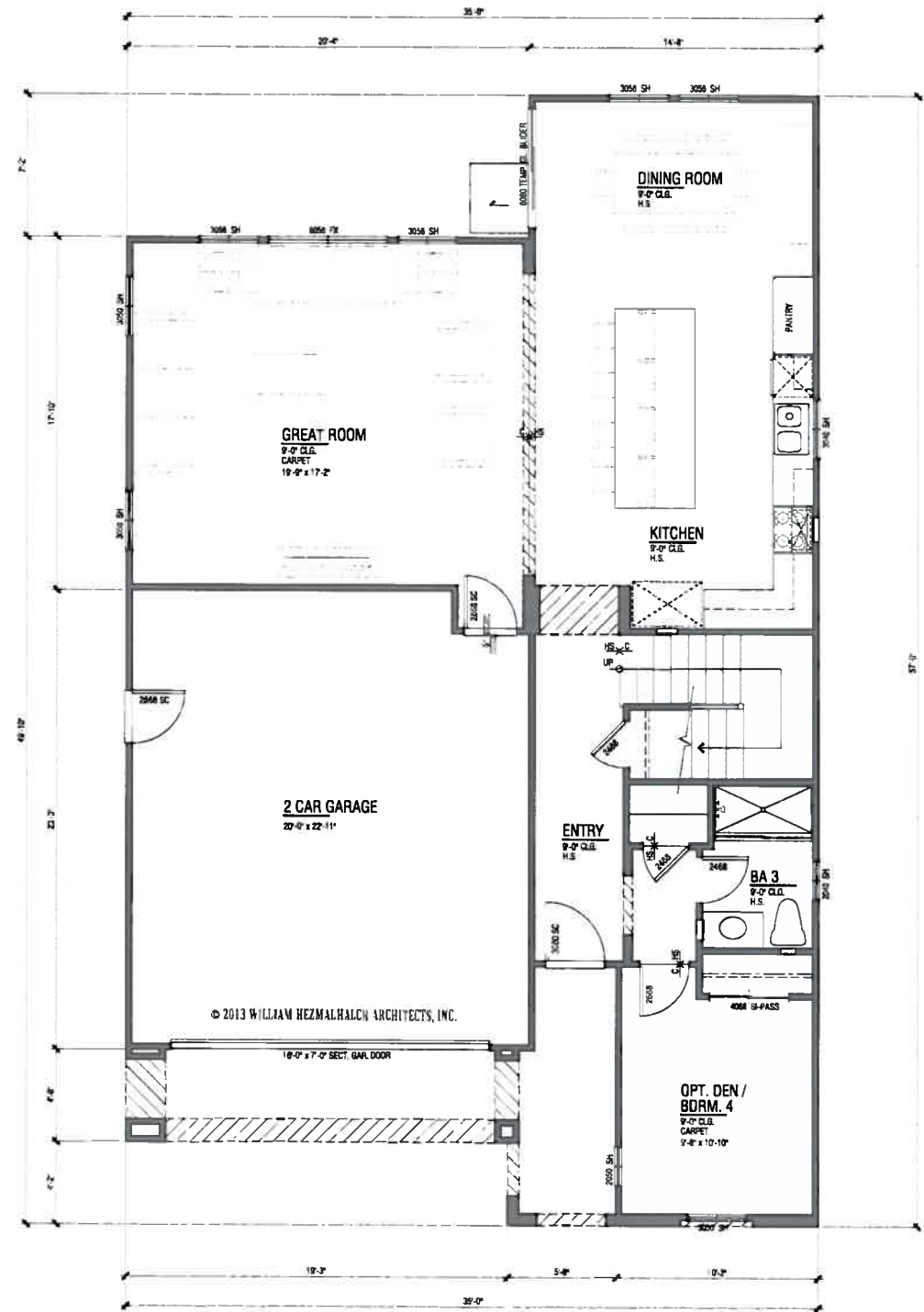

Lower Floor - 1,148 SF

Plan 3
2,624 SF
5 Bdrm/4 Ba
2 Car Garage

WAGNER SITE
Pleasanton, California
Ponderosa Homes



WILLIAM HEZMALHALCH ARCHITECTS INC.
5000 EXECUTIVE PARKWAY SUITE 375 SAN RAMON CA 94583-4210
925 463 1700 fax 949 250 1529
2850 REDHILL AVENUE SUITE 200 SANTA ANA CA 92705-5543
949 250 0507 www.wharchitects.com fax 949 250 1529

Revised May 22, 2013

December 18, 2012

3.1

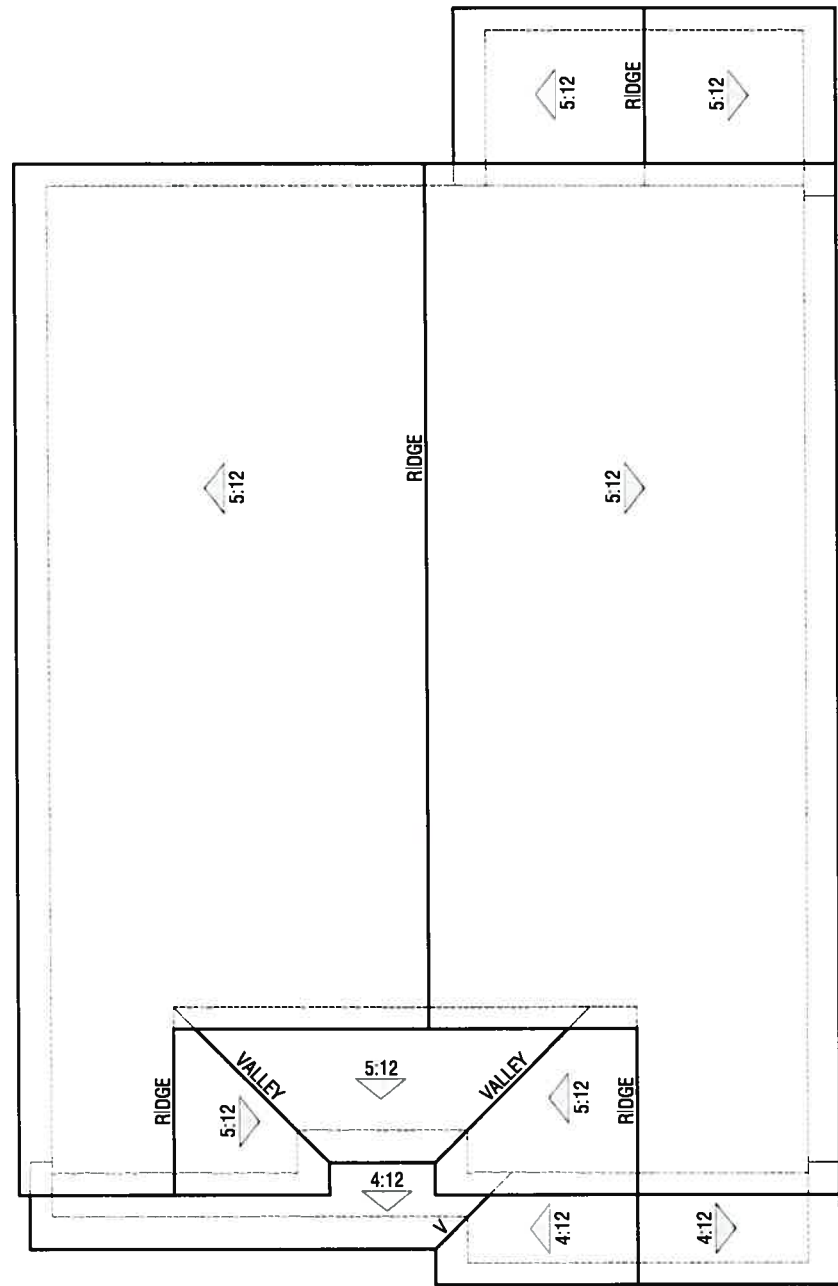

Elevation 'B' - Craftsman

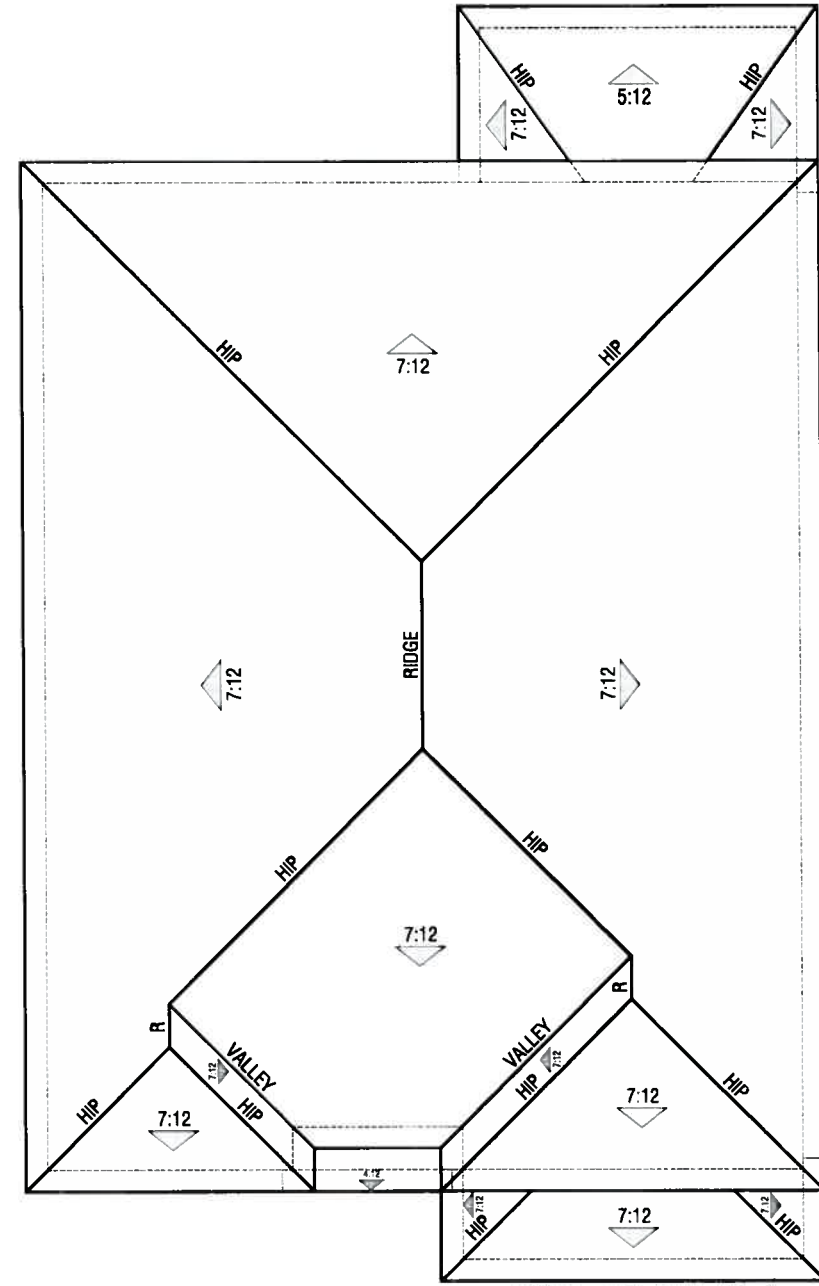

Elevation 'A' - Cottage

Plan 3

2,624 SF
5 Bdrm/4 Ba
2 Car Garage

WAGNER SITE
Pleasanton, California
Ponderosa Homes



© 2013 WILLIAM HEZMALHALCH ARCHITECTS, INC.

WH
WILLIAM HEZMALHALCH
ARCHITECTS INC.
5000 EXECUTIVE PARKWAY, SUITE 375 SAN RAMON CA 94583-4211
925 463 1700 fax 949 250 1529
2860 REDHILL AVENUE, SUITE 200 SANTA ANA CA 92705-6543
949 250 0607 www.wharchitects.com fax 949 250 1529

Revised May 22, 2013

December 18, 2012

3.2



NOTE - Artist conception; colors, materials and application may vary.



© 2013 WILLIAM HEZMALHALCH ARCHITECTS, INC.

Elevation 'B' - Craftsman: Color Scheme 5

ROOF: COMPOSITION SHINGLE ROOF
 FASCIA: 2 x 6 BARGE BOARD, WOOD OUTLOOKER & RAFTER TAILS
 GABLE: HORIZONTAL LAP SIDING
 WALL: STUCCO
 TRIM: STUCCO OVER FOAM TRIM PER ARCHITECTURAL STYLE
 WINDOW: VINYL WINDOW FRAMES WITH MULLION
 ACCENTS: WOOD COLUMNS WITH MANUFACTURED STONE VENEER BASE
 WOOD POTSHELF WITH CORBEL
 ENTRY DOOR ACCENT COLOR
 GARAGE DOOR: METAL SECTIONAL ROLL-UP GARAGE DOOR PER ARCHITECTURAL STYLE, WITH GLASS LITES

Plan 3

2,624 SF
 5 Bdrm/4 Ba
 2 Car Garage

WAGNER SITE
 Pleasanton, California
 Ponderosa Homes

Elevation 'A' - Cottage: Color Scheme 1

ROOF: COMPOSITION SHINGLE ROOF
 FASCIA: 2 x 6 BARGE BOARD
 WALL: STUCCO
 TRIM: STUCCO OVER FOAM TRIM PER ARCHITECTURAL STYLE
 WINDOW: VINYL WINDOW FRAMES WITH MULLION
 ACCENTS: PREFABRICATED SHUTTERS AND ENTRY DOOR ACCENT COLOR
 STONE: MANUFACTURED STONE VENEER
 GARAGE DOOR: METAL SECTIONAL ROLL-UP GARAGE DOOR PER ARCHITECTURAL STYLE, WITH GLASS LITES



© 2012 WILLIAM HEZMALHALCH ARCHITECTS, INC.

Revised May 22, 2013

December 18, 2012

3.3

WH
 WILLIAM HEZMALHALCH
 ARCHITECTS INC.
 5000 EXECUTIVE PARKWAY, SUITE 375 SAN RAMON CA 94583-4211
 925 463 1700 fax 949 250 1529
 2850 REDHILL AVENUE, SUITE 200 SANTA ANA CA 92705-5543
 949 250 0607 www.wharchitects.com fax 949 250 1529

2012032 - Wagner Site - Pleasanton, CA



Rear Elevation

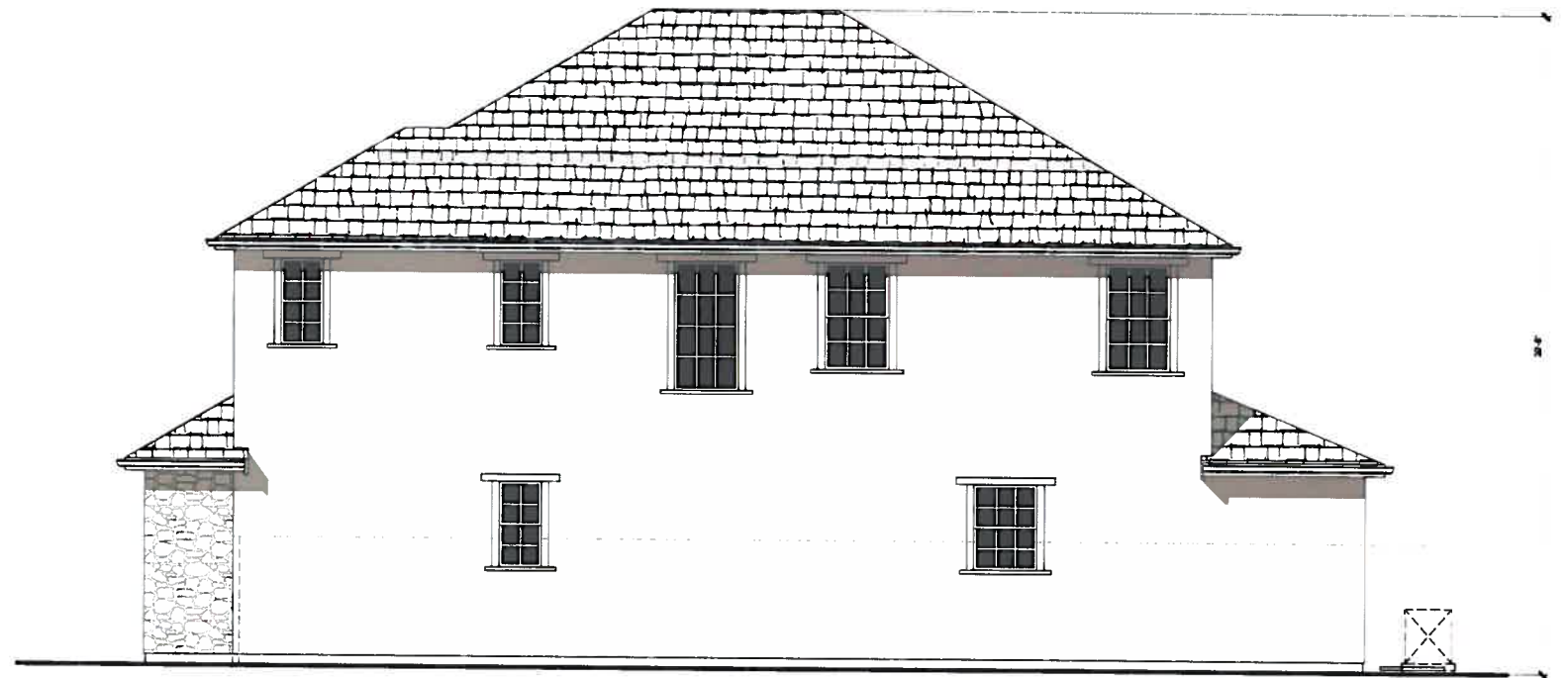

Right Elevation

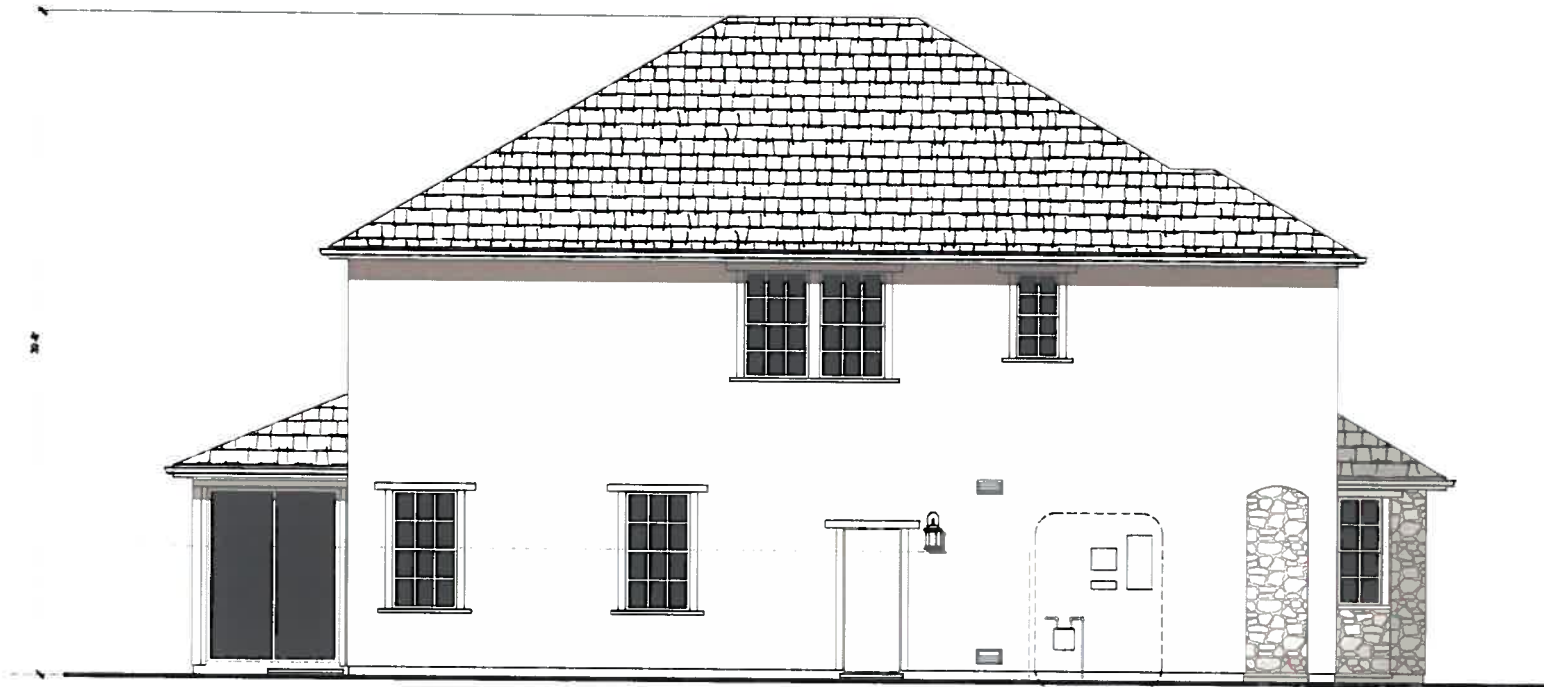

Left Elevation

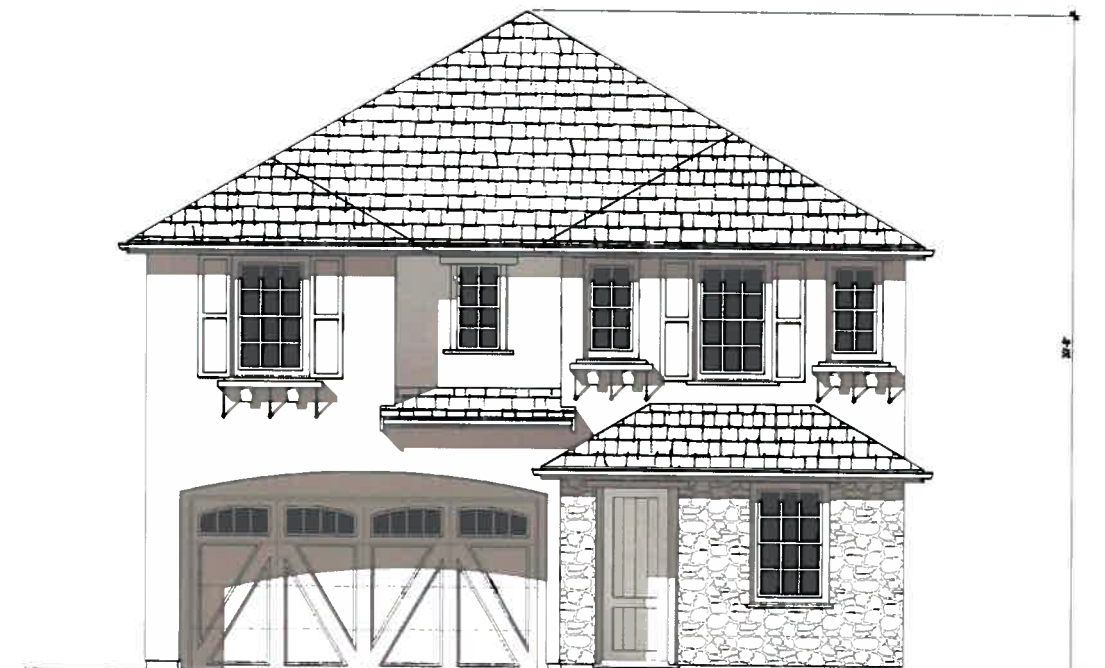

Front Elevation

© 2013 WILLIAM HEZMALHALCH ARCHITECTS, INC.

Plan 3
Elevation 'A'

- ROOF: COMPOSITION SHINGLE ROOF
- FASCIA: 2 x 6 BARGE BOARD
- WALL: STUCCO
- TRIM: STUCCO OVER FOAM TRIM PER ARCHITECTURAL STYLE
- WINDOW: VINYL WINDOW FRAMES WITH MULLION
- ACCENTS: PREFABRICATED SHUTTERS AND ENTRY DOOR ACCENT COLOR
- STONE: MANUFACTURED STONE VENEER
- GARAGE DOOR: METAL SECTIONAL ROLL-UP GARAGE DOOR PER ARCHITECTURAL STYLE, WITH GLASS LITES

WAGNER SITE
Pleasanton, California
Ponderosa Homes



© 2012 WILLIAM HEZMALHALCH ARCHITECTS, INC.



WILLIAM HEZMALHALCH ARCHITECTS, INC.
5000 EXECUTIVE PARKWAY SUITE 175 SAN RAMON CA 94583-4211
925 483 1700 fax 949 250 1529
2850 REDHILL AVENUE SUITE 200 SANTA ANA CA 92705-6543
949 250 0607 www.wharchitects.com fax 949 250 1529

Revised May 22, 2013

December 18, 2012

3.4

2012032 - Wagner Site - Pleasanton, CA



Rear Elevation



Right Elevation



Left Elevation

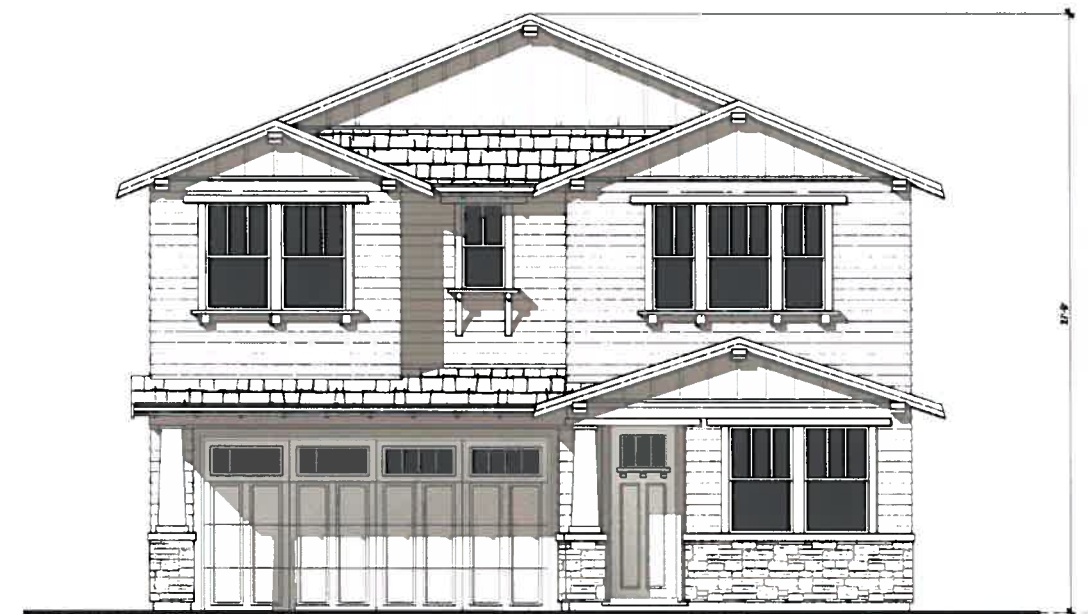

Front Elevation

Plan 3
Elevation 'B'

WAGNER SITE
Pleasanton, California
Ponderosa Homes

- ROOF: COMPOSITION SHINGLE ROOF
- FASCIA: 2 x 6 BARGE BOARD, WOOD OUTLOOKER & RAFTER TAILS
- GABLE: HORIZONTAL LAP SIDING
- WALL: STUCCO
- TRIM: STUCCO OVER FOAM TRIM PER ARCHITECTURAL STYLE
- WINDOW: VINYL WINDOW FRAMES WITH MULLION
- ACCENTS: WOOD COLUMNS WITH MANUFACTURED STONE VENEER BASE
- WOOD POTSHIELD WITH CORBEL
- ENTRY DOOR ACCENT COLOR
- GARAGE DOOR: METAL SECTIONAL ROLL-UP GARAGE DOOR PER ARCHITECTURAL STYLE, WITH GLASS LITES



© 2012 WILLIAM HEZMALHALCH ARCHITECTS, INC.

© 2013 WILLIAM HEZMALHALCH ARCHITECTS, INC.

Revised May 22, 2013

December 18, 2012

3.5



WILLIAM HEZMALHALCH ARCHITECTS, INC.
9111 BOLLINGER CANYON ROAD SUITE 405 SAN RAMON CA 94583-0196
925 463 1700 fax 925 463 1725
2060 REDHILL AVENUE SUITE 200 SANTA ANA CA 92705-0943
949 250 0607 www.wharchitects.com fax 949 250 1529

January 4, 2013

PONDEROSA HOMES
WAGNER SITE
 Pleasanton, California

Project #2012032

EXTERIOR COLOR & MATERIALS

SCHEME 1 of 6

'A' Elevations Only, Cottage

MATERIAL	COLOR	MANUFACTURER
ROOFING: Composition Shingles	SLATE T40 TIMBERLINE PRESTIQUE HIGH DEFINITION SHINGLES	GAF / ELK
MANUFACTURED STONE <i>(Standard Raked Joints)</i>	MONTECITO CLIFFSTONE	ELDORADO
MORTAR @ STONE	KHAKI	ORCO
GUTTERS & DOWNSPOUTS	Match Adjacent Color	KELLY-MOORE
STUCCO COLOR	26 OYSTER	KELLY-MOORE
TRIM COLOR #1 <i>(applied to):</i> Garage Door Louvered Vents Secondary Doors Stucco Trim	KM 3942-2 TROPICAL TAN	KELLY-MOORE
TRIM COLOR #2 <i>(applied to):</i> Barge Boards Braces Eaves Fascia Posts Railing Wood Trim	KM 3943-3 CREME DE CARAMEL	KELLY-MOORE
ACCENT COLOR <i>(applied to):</i> Front Door Shutters	KM 3831-3 KNAPPED FLINT	KELLY-MOORE
METAL COLOR <i>(applied to):</i> Metal Pot Shelves	AC 259-5 DUNGEON	KELLY-MOORE

Color Designer: Donna Aldrich

William Hezmalhalch Architects, Inc. © 2013

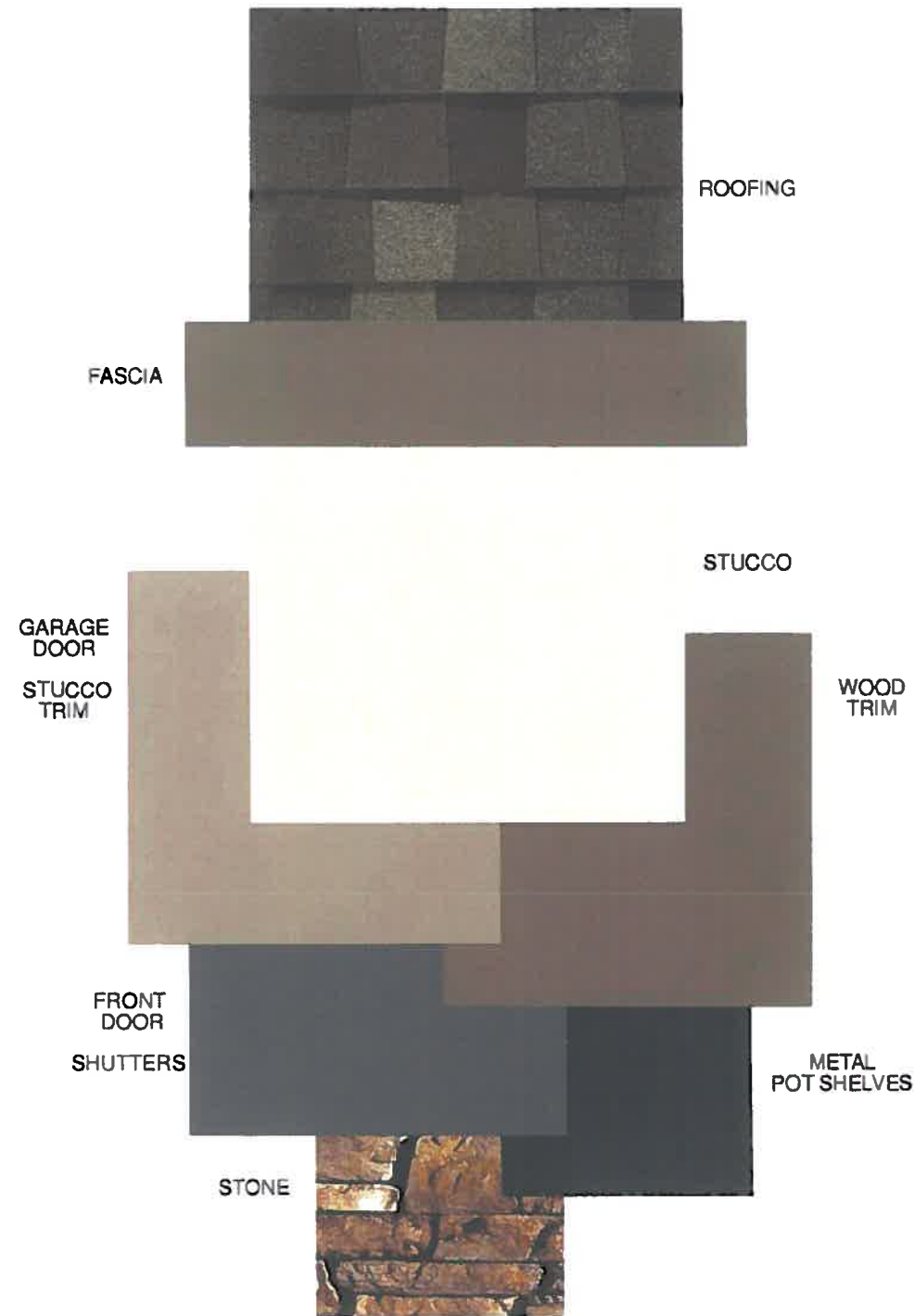

'A' ELEVATIONS ONLY - COTTAGE

WAGNER SITE

PLEASANTON, CALIFORNIA

1

PONDEROSA HOMES

WILLIAM HEZMALHALCH ARCHITECTS INC. © 2013

For exact color refer to manufacturers' actual samples

1/4/13

2012032

January 4, 2013

PONDEROSA HOMES
WAGNER SITE
 Pleasanton, California

Project #2012032

EXTERIOR COLOR & MATERIALS

SCHEME 2 of 6

'A' Elevations Only, Cottage

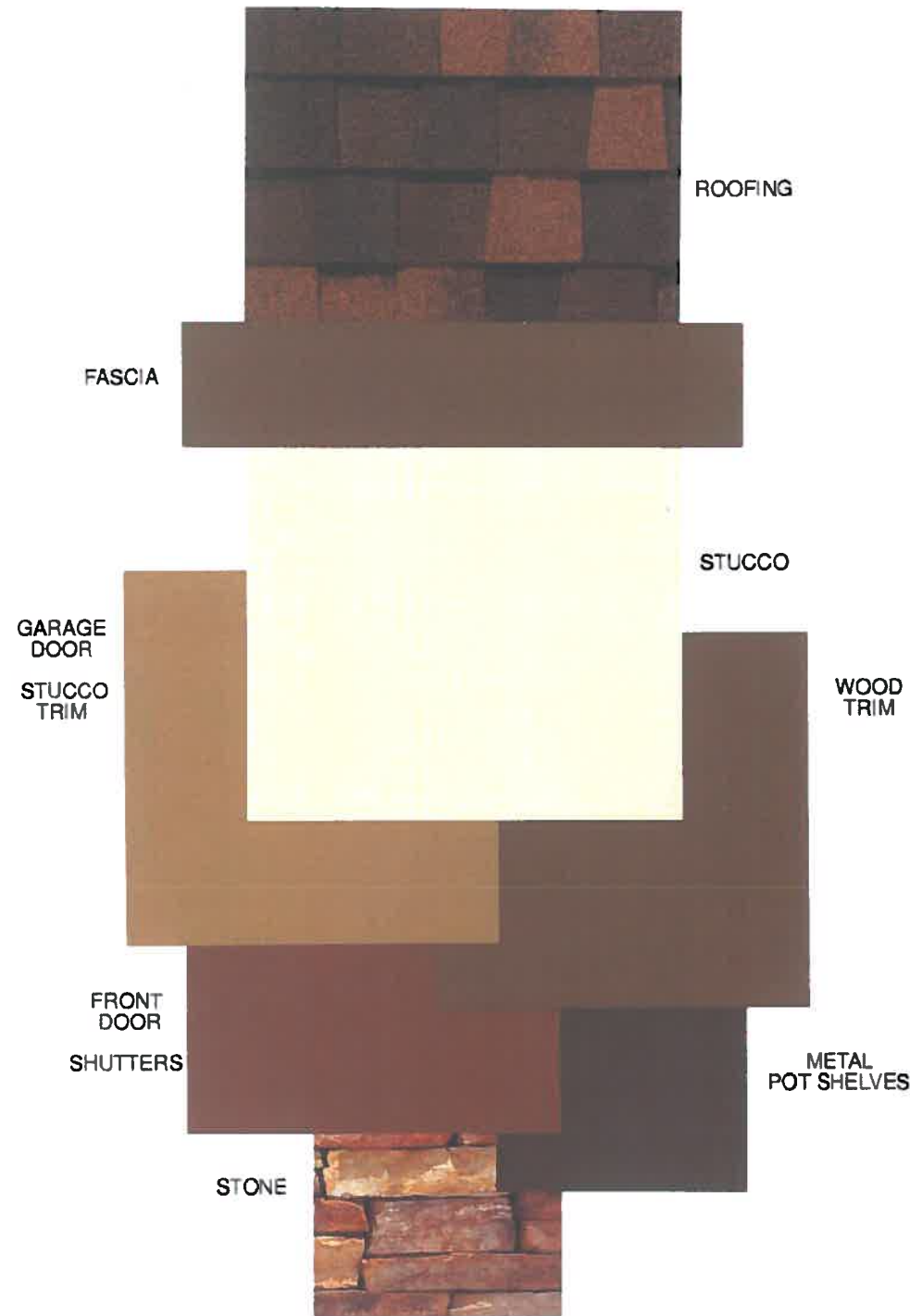

MATERIAL	COLOR	MANUFACTURER
ROOFING: Composition Shingles	HICKORY T40 TIMBERLINE PRESTIQUE HIGH DEFINITION SHINGLES	GAF / ELK
MANUFACTURED STONE (<i>Standard Raked Joints</i>)	CAMBRIA CLIFFSTONE	ELDORADO
MORTAR @ STONE	CAMEL	ORCO
GUTTERS & DOWNSPOUTS	Match Adjacent Color	KELLY-MOORE
STUCCO COLOR	KM 3988-2 PALE PORTABELLA	KELLY-MOORE
TRIM COLOR #1 (<i>applied to:</i> Garage Door Louvered Vents Secondary Doors Stucco Trim	KM 4007-3 MEXICAN HILLS	KELLY-MOORE
TRIM COLOR #2 (<i>applied to:</i> Barge Boards Braces Eaves Fascia Posts Railing Wood Trim	AC 250-5 UMBER SHADOW	KELLY-MOORE
ACCENT COLOR (<i>applied to:</i> Front Door Shutters	KM 4056-5 WESTERN PURSUIT	KELLY-MOORE
METAL COLOR (<i>applied to:</i> Metal Pot Shelves	AC 251-5 VERMEER'S FIELDS	KELLY-MOORE

Color Designer: Donna Aldrich

William Hezmalhalch Architects, Inc. © 2013

'A' ELEVATIONS ONLY - COTTAGE

WAGNER SITE
 PLEASANTON, CALIFORNIA

1/4/13

2012032

2
 PONDEROSA HOMES
 WILLIAM HEZMALHALCH ARCHITECTS INC © 2013

For exact color refer to manufacturers' actual samples

January 4, 2013

PONDEROSA HOMES
WAGNER SITE
 Pleasanton, California

Project #2012032

EXTERIOR COLOR & MATERIALS

SCHEME 3 of 6

'A' Elevations Only, Cottage

MATERIAL	COLOR	MANUFACTURER
ROOFING: Composition Shingles	WEATHERED WOOD T40 TIMBERLINE PRESTIQUE HIGH DEFINITION SHINGLES	GAF / ELK
MANUFACTURED STONE (Standard Raked Joints)	MANZANITA CLIFFSTONE	ELDORADO
MORTAR @ STONE	BROWN	ORCO
GUTTERS & DOWNSPOUTS	Match Adjacent Color	KELLY-MOORE
STUCCO COLOR	228 CHARRO	KELLY-MOORE
TRIM COLOR #1 (applied to): Garage Door Louvered Vents Secondary Doors Stucco Trim	KM 3975-3 AFRICAN PLAIN	KELLY-MOORE
TRIM COLOR #2 (applied to): Barge Boards Braces Eaves Fascia Posts Railing Wood Trim	KM 3944-5 MOCHA MOUSSE	KELLY-MOORE
ACCENT COLOR (applied to): Front Door Shutters	KM 3920-5 FORTUNE LEAVES	KELLY-MOORE
METAL COLOR (applied to): Metal Pot Shelves	KM 3928-5 HAZEL'S COAT	KELLY-MOORE

Color Designer: Donna Aldrich

William Hezmalhalch Architects, Inc. © 2013

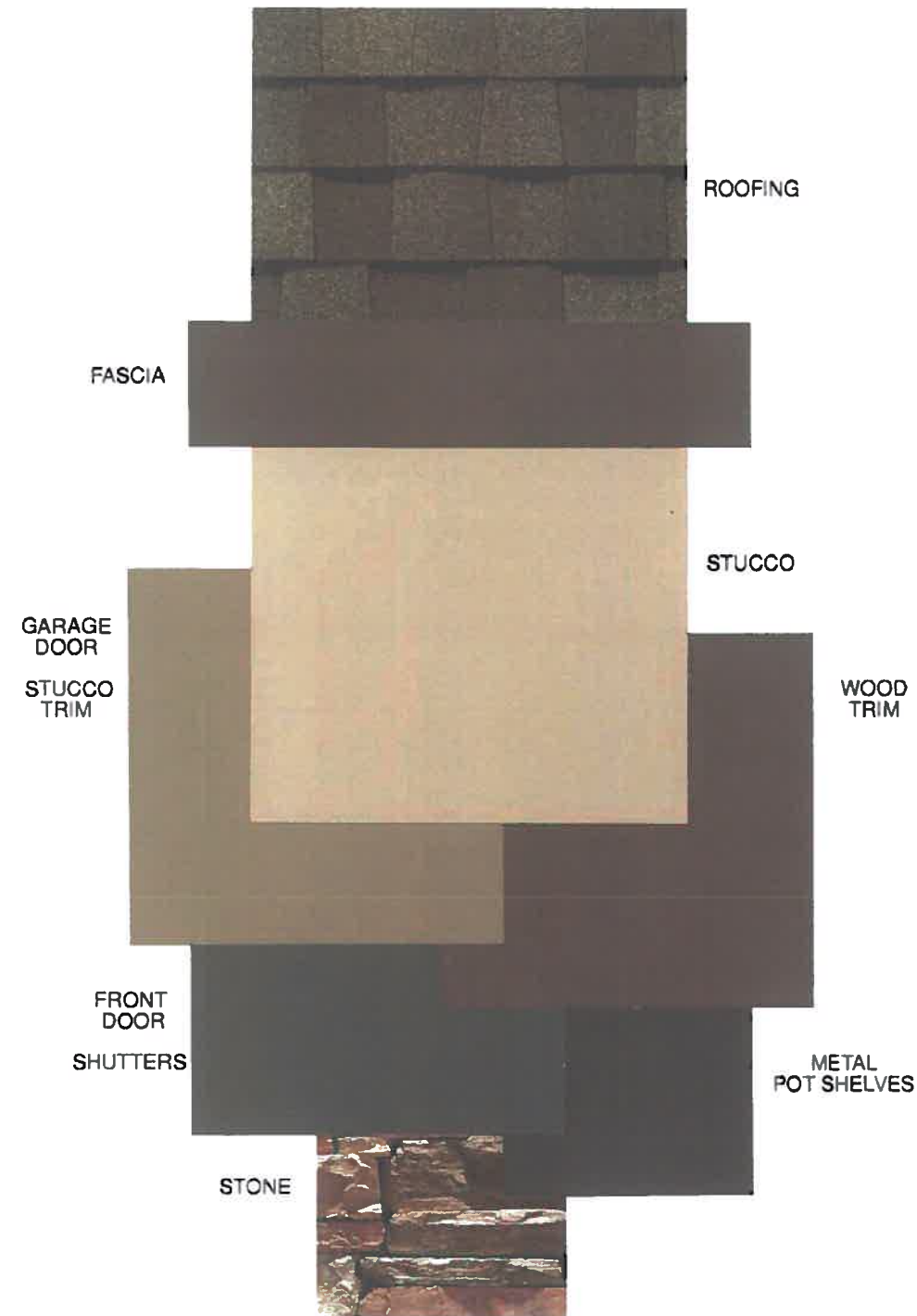

'A' ELEVATIONS ONLY - COTTAGE

WAGNER SITE

PLEASANTON, CALIFORNIA

3

PONDEROSA HOMES

WILLIAM HEZMALHALCH ARCHITECTS INC. © 2013

For exact color refer to manufacturers' actual samples

1/4/13

2012032

January 4, 2013

PONDEROSA HOMES
WAGNER SITE
Pleasanton, California

Project #2012032

EXTERIOR COLOR & MATERIALS

SCHEME 4 of 6

'B' Elevations Only, Craftsman

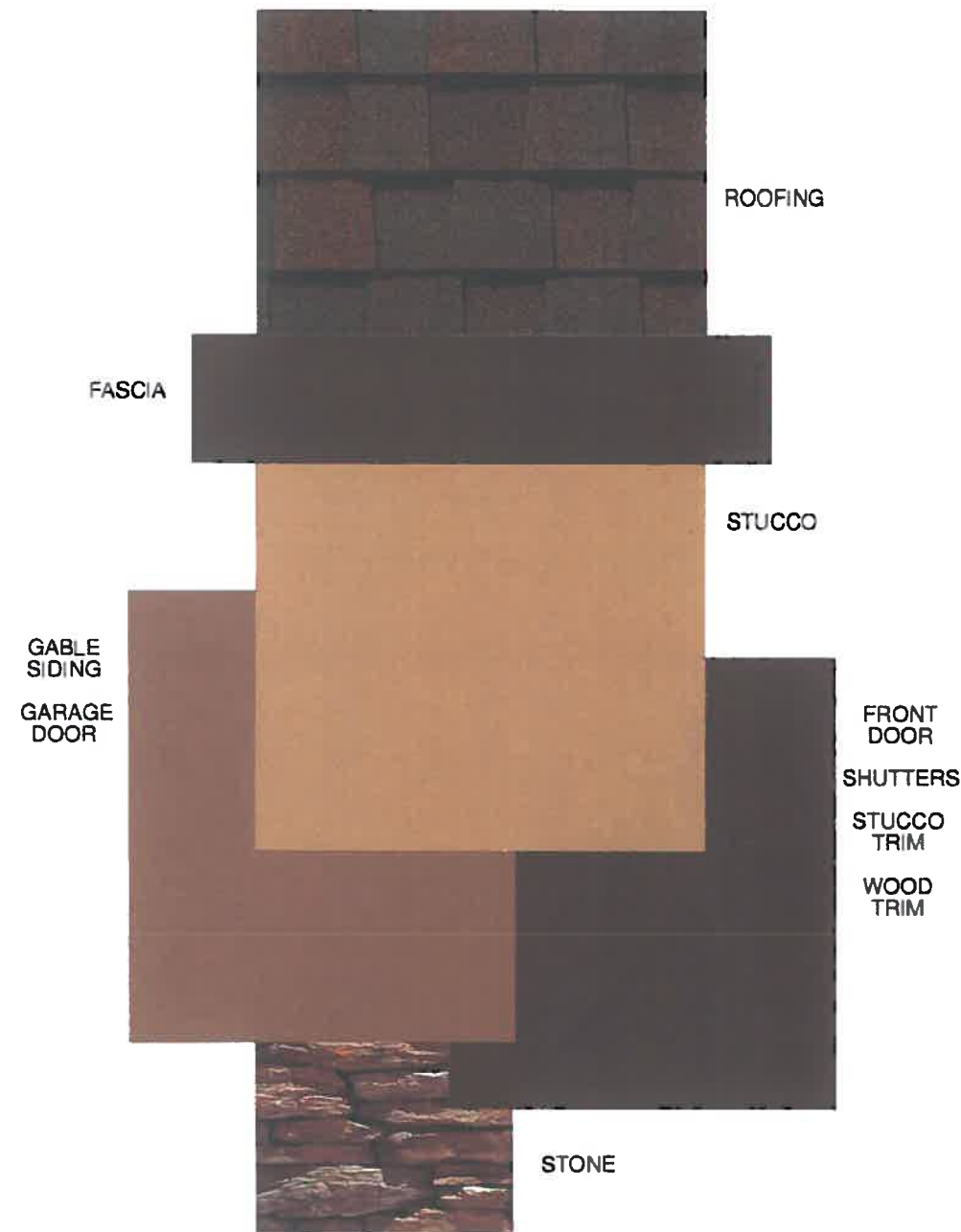

MATERIAL	COLOR	MANUFACTURER
ROOFING: Composition Shingles	BARKWOOD T40 TIMBERLINE PRESTIQUE HIGH DEFINITION SHINGLES	GAF / ELK
MANUFACTURED STONE (Standard Raked Joints)	PRESCOTT BLUFFSTONE	ELDORADO
MORTAR @ STONE	LATTE	ORCO
GUTTERS & DOWNSPOUTS	Match Adjacent Color	KELLY-MOORE
STUCCO COLOR	KM 4014-3 TUMBLE TAN	KELLY-MOORE
TRIM COLOR #1 (applied to): Barge Boards Braces Eaves Fascia Front Door Louvered Vents Outlookers Posts Pot Shelves Rafter Tails Railing Shutters Stucco Trim Wood Trim	417 OXFORD BROWN	KELLY-MOORE
TRIM COLOR #2 (applied to): Gable Siding Garage Door Secondary Doors	KM 4023-3 DIG IT	KELLY-MOORE

Color Designer: Donna Aldrich

William Hezmalhalch Architects, Inc. © 2013

'B' ELEVATIONS ONLY - CRAFTSMAN

WAGNER SITE

PLEASANTON, CALIFORNIA

4

PONDEROSA HOMES

WILLIAM HEZMALHALCH ARCHITECTS INC © 2013

For exact color refer to manufacturers' actual samples

1/4/13

2012032

January 4, 2013

PONDEROSA HOMES
WAGNER SITE
 Pleasanton, California

Project #2012032

EXTERIOR COLOR & MATERIALS

SCHEME 5 of 6

'B' Elevations Only, Craftsman

MATERIAL	COLOR	MANUFACTURER
ROOFING: Composition Shingles	WEATHERED WOOD T40 TIMBERLINE PRESTIQUE HIGH DEFINITION SHINGLES	GAF / ELK
MANUFACTURED STONE (<i>Standard Raked Joints</i>)	LA PLATA BLUFFSTONE	ELDORADO
MORTAR @ STONE	CAMEL	ORCO
GUTTERS & DOWNSPOUTS	Match Adjacent Color	KELLY-MOORE
STUCCO COLOR	KM 3990-3 SOFT MOCCASIN	KELLY-MOORE
TRIM COLOR #1 (<i>applied to:</i> Barge Boards Braces Eaves Fascia Front Door Louvered Vents Outlookers Posts Pot Shelves Rafter Tails Railing Shutters Stucco Trim Wood Trim	KM 3976-5 OLIVE GROVE	KELLY-MOORE
TRIM COLOR #2 (<i>applied to:</i> Gable Siding Garage Door Secondary Doors	196 VILLITA	KELLY-MOORE

Color Designer: Donna Aldrich

William Hezmalhalch Architects, Inc. © 2013

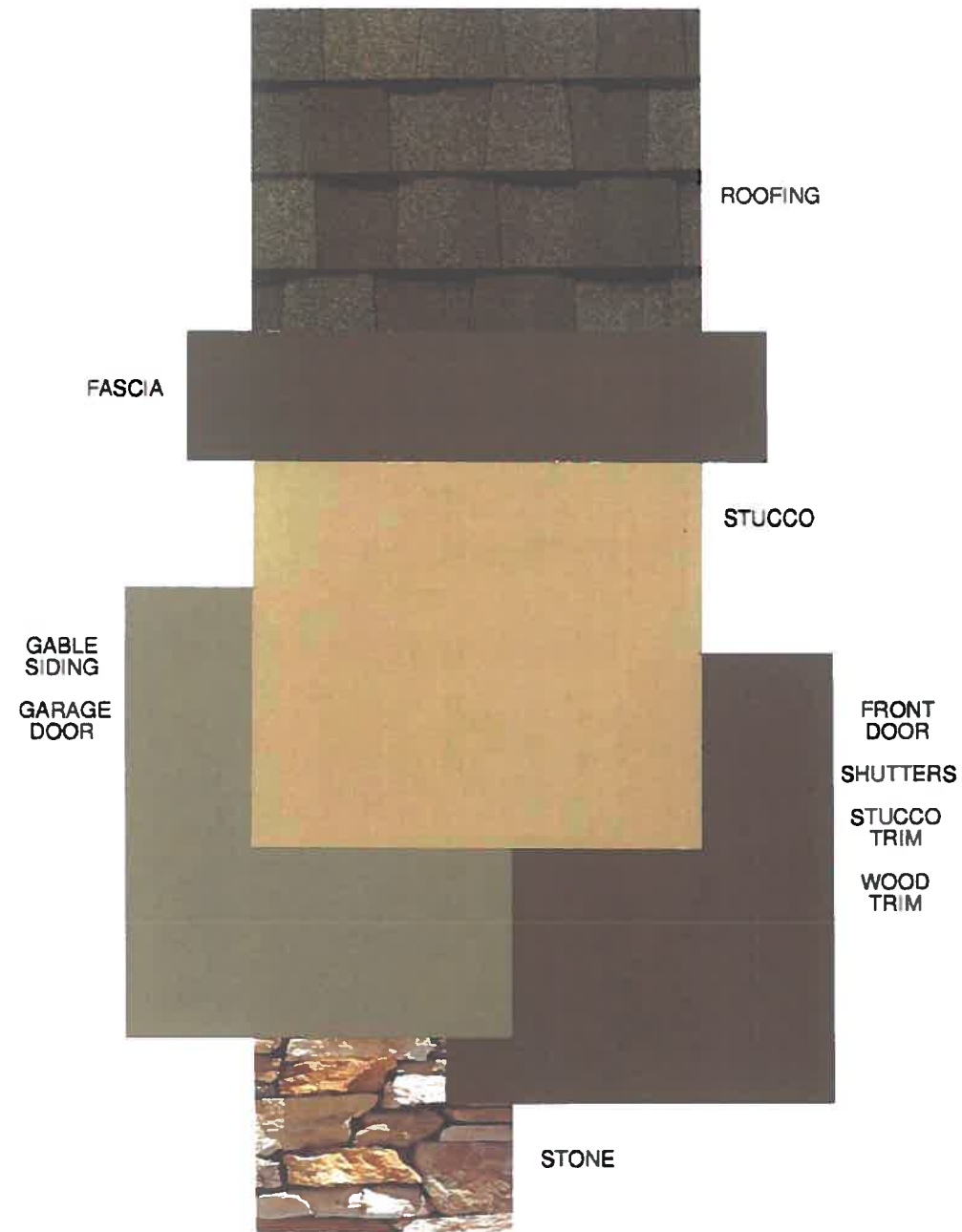

'B' ELEVATIONS ONLY - CRAFTSMAN

WAGNER SITE

PLEASANTON, CALIFORNIA

5

PONDEROSA HOMES

WILLIAM HEZMALHALCH ARCHITECTS INC © 2013

For exact color refer to manufacturers' actual samples.

1/4/13

2012032

January 4, 2013

PONDEROSA HOMES
WAGNER SITE
 Pleasanton, California

Project #2012032

EXTERIOR COLOR & MATERIALS

SCHEME 6 of 6

'B' Elevations Only, Craftsman

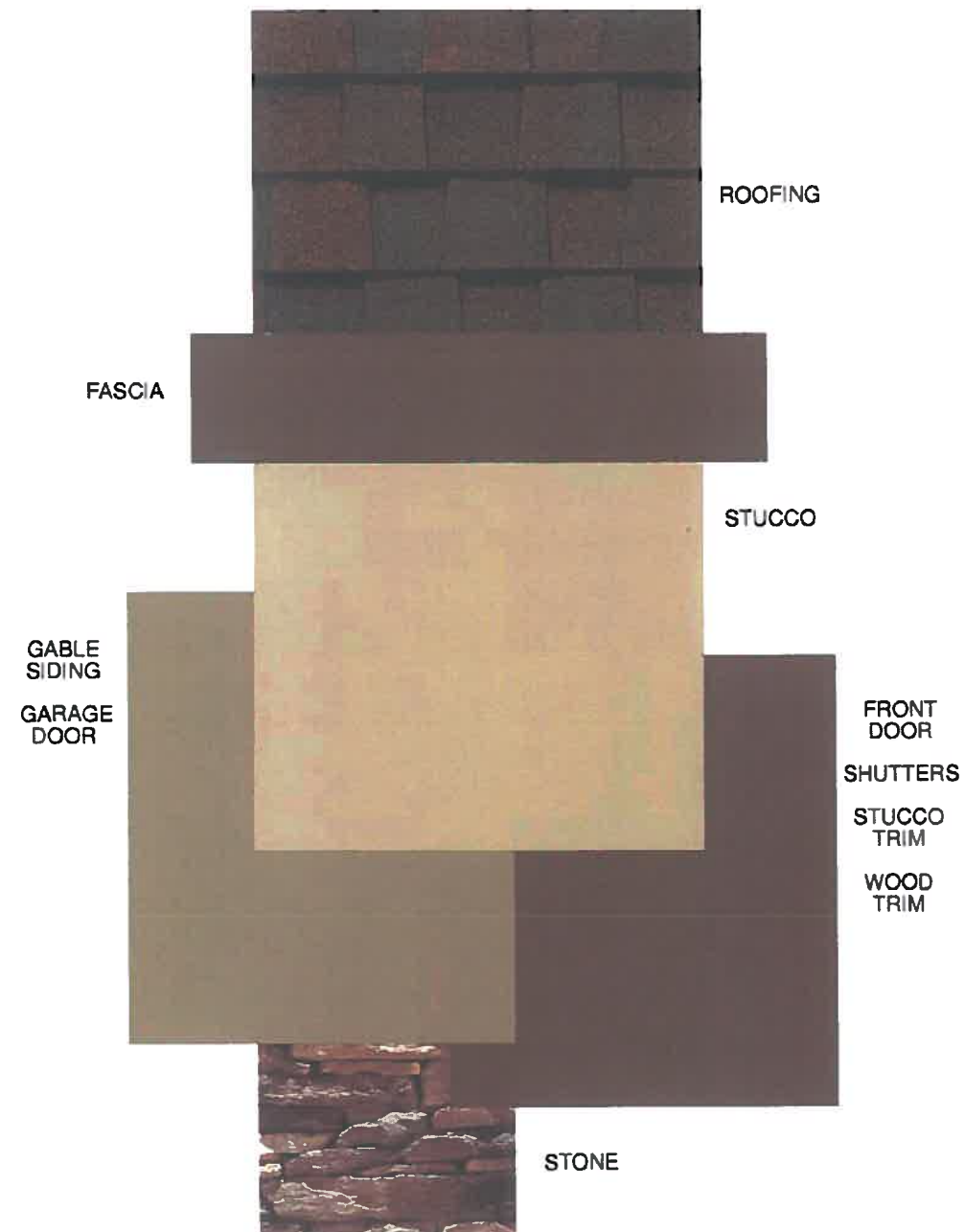

MATERIAL	COLOR	MANUFACTURER
ROOFING: Composition Shingles	BARKWOOD T40 TIMBERLINE PRESTIQUE HIGH DEFINITION SHINGLES	GAF / ELK
MANUFACTURED STONE (<i>Standard Raked Joints</i>)	MINERET BLUFFSTONE	ELDORADO
MORTAR @ STONE	CARAMEL	ORCO
GUTTERS & DOWNSPOUTS	Match Adjacent Color	KELLY-MOORE
STUCCO COLOR	171 SAND PEBBLE	KELLY-MOORE
TRIM COLOR #1 (<i>applied to:</i> Barge Boards Braces Eaves Fascia Front Door Louvered Vents Outlookers Posts Pot Shelves Rafter Tails Railing Shutters Stucco Trim Wood Trim	KM 4192-5 RAW EARTH	KELLY-MOORE
TRIM COLOR #2 (<i>applied to:</i> Gable Siding Garage Door Secondary Doors	KM 3975-3 AFRICAN PLAIN	KELLY-MOORE

Color Designer: Donna Aldrich

William Hezmalhalch Architects, Inc. © 2013

'B' ELEVATIONS ONLY - CRAFTSMAN

WAGNER SITE

PLEASANTON, CALIFORNIA

6

PONDEROSA HOMES

WILLIAM HEZMALHALCH ARCHITECTS INC. © 2013

For exact color refer to manufacturers' actual samples.

1/4/13

2012032

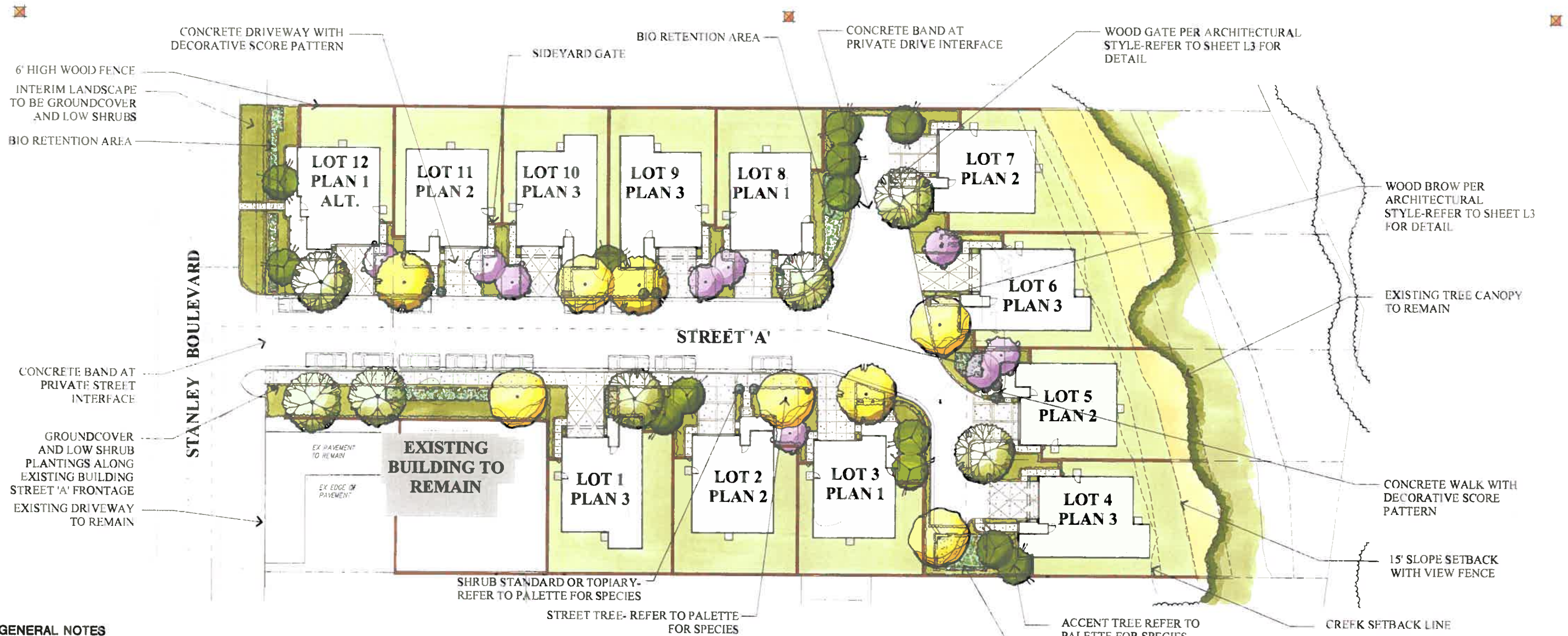

GENERAL NOTES

- 1. ALL STREET TREES TO BE PLANTED WITH ROOT BARRIERS PER CITY OF PLEASANTON STANDARD DETAILS
- 2. ALL TREES TO RECEIVE TREE STAKE PER CITY OF PLEASANTON STANDARD DETAILS
- 3. ALL PLANTING TO CONFORM TO CITY OF PLEASANTON WATER EFFICIENT LANDSCAPE ORDINANCE

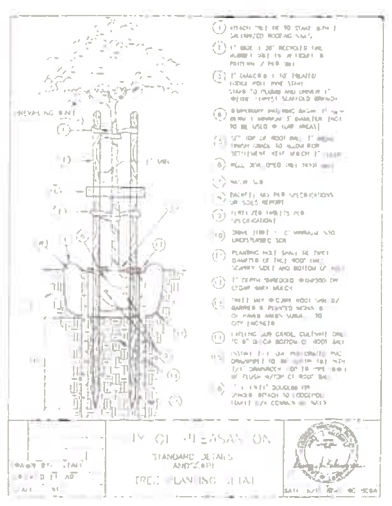

PRELIMINARY TREE PALETTE

BOTANICAL NAME	COMMON NAME	SIZE	WATER USE
STREET TREES			
ACER RED SUNSET	RED MAPLE	10 GAL	MEDIUM
FRAXINUS RAYWOOD	RAYWOOD ASH	10 GAL	MEDIUM
MAGNOLIA GRANDIFLORA MAJESTIC BEAUTY	MAGNOLIA	10 GAL	MEDIUM
ACCENT TREES			
CORNUS WELCHII	TRI COLORED DOGWOOD	5 GALLON	MEDIUM
CERCIS OCCIDENTALIS	WESTERN REDBUD	10 GALLON	LOW
LAGERSTROEMIA NOICA	ORANGE NITRILE	10 GALLON	LOW
LAURUS NOBILIS	GRECIAN LAUREL	10 GALLON	LOW
MAGNOLIA G. ST. MARYS	SOUTHERN MAGNOLIA	10 GALLON	MEDIUM
OLEA EUROPAEA SAN GABRIEL	FRUITLESS OLIVE	10 GALLON	LOW
PRUNUS CAROLINANA	CAROLINA CHERRY	10 GALLON	LOW
PRUNUS C. KRAUTER VEKULVIS	PURPLE-LEAF PLUM	10 GALLON	LOW
PRUNUS SARGENTII	SARGENT CHERRY	10 GALLON	MEDIUM
PYRUS C. BRADFORD	BRADFORD PEAR	10 GALLON	MEDIUM
PYRUS KAWAKAMI	EVERGREEN PEAR	10 GALLON	MEDIUM
VITEX AGNUS-CASTUS	CHASTE TREE	10 GALLON	LOW
STANDARDS AND TOPIARIES			
LIQUISTRUM JAPONICUM J-TREE	JAPANESE PRIVET TOPIARY	15 GALLON	MEDIUM
ROSA STANDARD	ORNAMENTAL TREE ROSE	5 GALLON	MEDIUM
THUJA TOPIARIES	ARBORVITAE TOPIARY	10 GALLON	MEDIUM

BIO RETENTION AREA SHRUB PALETTE

BOTANICAL NAME	COMMON NAME	SIZE	WATER USE
SHRUBS - BIO-RETENTION AREAS			
AGAPANTHUS A. PETER PAY	DWARF LILY-OF-THE-VALLEY	GALLON	MEDIUM
ANEMONE HYBRIDA	JAPANESE ANEMONE	GALLON	MEDIUM
BUDLEIA DAVIDII	BUTTERFLY BUSH	5 GALLON	LOW
CAREX TUMICOLA	BERKELEY SEDGE	GALLON	LOW
DIANELLA INTERMEDIA	NO COMMON NAME	GALLON	LOW
DIETES BICOLOR	FORTNIGHT LILY	GALLON	LOW
DIETES IRIDIODES	DAYLILY	GALLON	MEDIUM
HEMEROCALLIS HYBRIDS	DWARF YAUPON	GALLON	LOW
ILEX VOMITORIA NANA	SOFT RUSH	GALLON	LOW
JUNCUS EFFUSUS	CALIFORNIA RUSH	GALLON	HIGH
JUNCUS PATENS	DWARF HEAVENLY BAMBOO	GALLON	LOW
NANQUINA DOMESTICA GULF STREAM	PETITE PINK QUELONDER	GALLON	LOW
NERIUM O. PETITE PINK	NEW ZEALAND FLAX	5 GALLON	LOW
PHORMIUM T. MAORI MAOEN	NO COMMON NAME	GALLON	MEDIUM
RUELLIA BRITTONIANA	ZE-PHYR LILY	GALLON	MEDIUM
ZEPHYRANTHES CANADA			

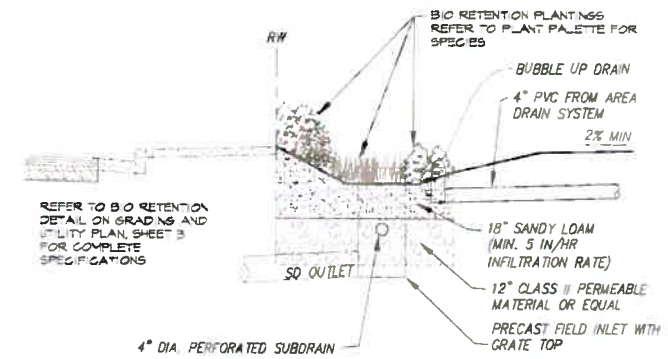

BIO-RETENTION PLANTING

RIPLEY DESIGN

RIPLEY DESIGN GROUP, INC.
 LANDSCAPE ARCHITECTURE
 LAND PLANNING
 1615 BONANZA STREET
 SUITE 314
 WALNUT CREEK, CA 94596
 TEL: 925.938.7377
 FAX: 925.938.7436

PONDEROSA HOMES

Preliminary Landscape Site Plan

Wagner Property

Pleasanton, California

L1

May 22, 2013

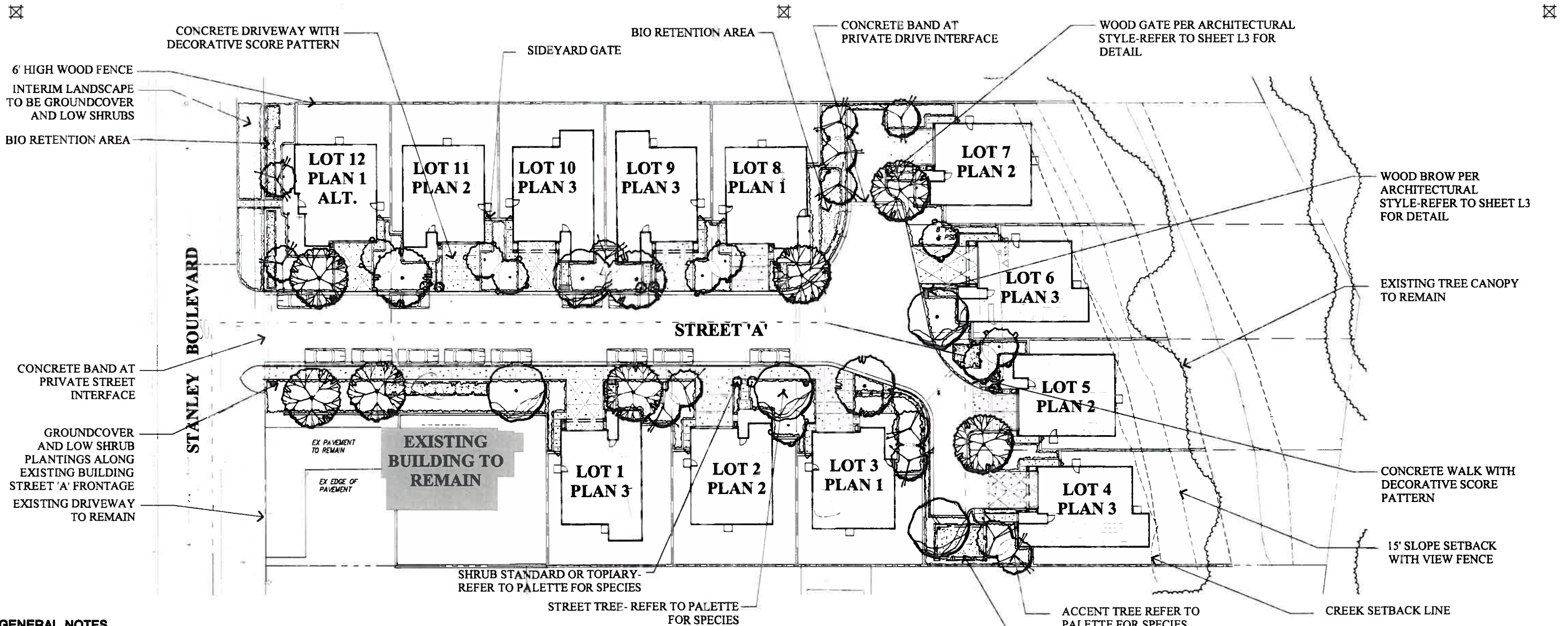

GENERAL NOTES

- ALL STREET TREES TO BE PLANTED WITH ROOT BARRIERS PER CITY OF PLEASANTON STANDARD DETAILS.
- ALL TREES TO RECEIVE TREE STAKES PER CITY OF PLEASANTON STANDARD DETAILS.
- ALL PLANTING TO CONFORM TO CITY OF PLEASANTON WATER EFFICIENT LANDSCAPE ORDINANCE.

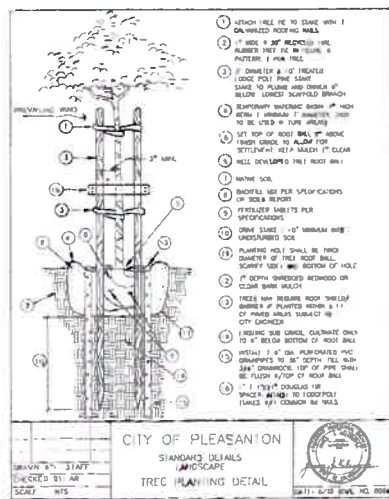

PRELIMINARY TREE PALETTE

BOTANICAL NAME	COMMON NAME	SIZE	WATER USE
STREET TREES			
ACER 'RED SUNSET'	RED MAPLE	5 GAL.	MEDIUM
FRAXINUS 'RAYWOOD'	RAYWOOD ASH	5 GAL.	MEDIUM
MAGNOLIA GRANDIFLORA 'MAJESTIC BEAUTY'	MAGNOLIA	5 GAL.	MEDIUM
ACCENT TREES			
CORNUS 'WELCH'	TRI COLORED DOGWOOD	5 GALLON	MEDIUM
CERCIS OCCIDENTALIS	WESTERN REDBUD	5 GALLON	LOW
LAGERSTROEMIA INDICA	CRAPE MYRTLE	5 GALLON	LOW
LAURUS NOBILIS	GRECIAN LAUREL	5 GALLON	LOW
MAGNOLIA G. 'ST. MARYS'	SOUTHERN MAGNOLIA	5 GALLON	MEDIUM
OLEA EUOPAEA 'SAN GABRIEL'	FRUITLESS OLIVE	5 GALLON	LOW
PRUNUS CAROLINA	CAROLINA CHERRY	5 GALLON	LOW
PRUNUS C. 'KRAUTER VESUVIUS'	PURPLE-LEAF PLUM	5 GALLON	LOW
PRUNUS SARGENTI	SARGENT CHERRY	5 GALLON	MEDIUM
PRUNUS C. 'BRADFORD'	BRADFORD PEAR	5 GALLON	MEDIUM
PRUNUS KAWAKAMI	EVERGREEN PEAR	5 GALLON	MEDIUM
VITEX AGNUS-CASTUS	CHASTE TREE	5 GALLON	LOW
STANDARDS AND TOPIARIES			
LIGSTRUM JAPONICUM 3-TIER	JAPANESE PRIVET TOPIARY	5 GALLON	MEDIUM
ROSA STANDARD	ORNAMENTAL TREE ROSE	5 GALLON	MEDIUM
THUJA TOPIARIES	ARBORVITAE TOPIARY	5 GALLON	MEDIUM

BIO RETENTION AREA SHRUB PALETTE

BOTANICAL NAME	COMMON NAME	SIZE	WATER USE
SHRUBS - BIO-RETENTION AREAS			
AGAPANTHUS A. 'PETER PAN'	OWARF LILY-OF-THE-NILE	5 GALLON	MEDIUM
ANEMONE HYBRIDA	JAPANESE ANEMONE	5 GALLON	MEDIUM
BUCCEA OAV OI	BUTTERFLY BUSH	5 GALLON	LOW
CAREX 'LUMICOLA	BERKELEY SEDGE	5 GALLON	LOW
D ANELLA 'N'ERMEIDA	NO COMMON NAME	5 GALLON	LOW
O ETES BICOLOR	FORTNIGHT LILY	5 GALLON	LOW
O ETES IRIDODES	GAY LILY	5 GALLON	LOW
HEMEROCALLIS HYBRIDS	OWARF YAUPOIN	5 GALLON	MEDIUM
ILEX VOMITORIA 'NANA'	SOFT RUSH	5 GALLON	LOW
JUNCUS EFFLUSUS	CALIFORNIA RUSH	5 GALLON	HIGH
JUNCUS PATENS	OWARF HEAVENLY BAMBOO	5 GALLON	LOW
NANDINA OOMESTICA 'GULF STREAM'	PETITE PINK OLEANDER	5 GALLON	LOW
NERIUM O. 'PETITE PINK'	NEW ZEALAND FLAX	5 GALLON	LOW
PHORMIUM T. 'MAORI MA DEN	NO COMMON NAME	5 GALLON	MEDIUM
RUELLIA BR 'TONANA	ZEPHYR LILY	5 GALLON	MEDIUM
ZEPHYRANTHES CANOIDA			

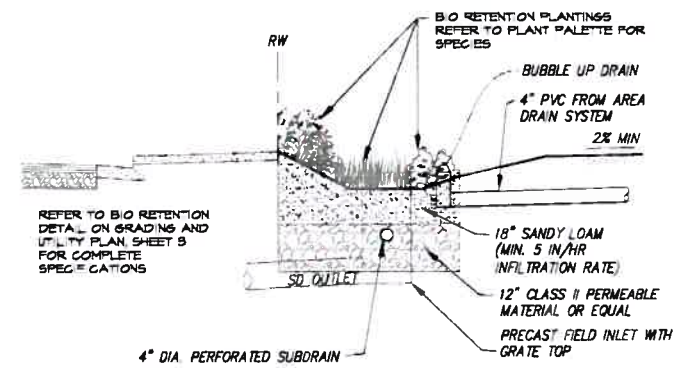

BIO-RETENTION PLANTING

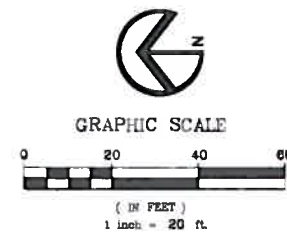

PONDEROSA HOMES

Preliminary Landscape Site Plan

Wagner Property

Pleasanton, California

L1

May 22, 2013

RIPLEY DESIGN GROUP

RIPLEY DESIGN GROUP, INC.
LANDSCAPE ARCHITECTURE
LAND PLANNING
1615 BONANZA STREET
SUITE 314
WALNUT CREEK, CA 94596
TEL: 925.938.7377
FAX: 925.938.7436

PRELIMINARY PLANT PALETTE

BOTANICAL NAME	COMMON NAME	SIZE	WATER USE
STREET TREES			
ACER RED SUNSET	RED MAPLE	5GAL	MEDIUM
FRAXINUS 'RAYWOOD'	RAYWOOD ASH	5GAL	MEDIUM
MAIGNOLIA GRANDIFLORA 'MAJESTIC BEAUTY'	MAGNOLIA	5GAL	MEDIUM
ACCENT TREES			
CORNUS WILLOW	TRI COLORED DOGWOOD	15 GALLON	MEDIUM
CERCIS OCCIDENTALIS	WESTERN REDBUD	15 GALLON	LOW
LAGERSTROEMIA NOICA	GRAPE HYDRANGEA	15 GALLON	LOW
LAURUS NOBILIS	GRECIAN LAUREL	15 GALLON	LOW
MAGNOLIA G. 'ST. MARYS'	SOUTHERN MAGNOLIA	15 GALLON	MEDIUM
O. EA. SUOPASA 'SAN GABRIEL'	FRUITLESS OLIVE	15 GALLON	LOW
PRUNUS CAROLIANA	CAROLINA CHERRY	15 GALLON	LOW
PRUNUS C. 'KRAUTER VESUVIUS'	PURPLE-LEAF PLUM	15 GALLON	LOW
PRUNUS SARGENTII	SARGENT CHERRY	15 GALLON	MEDIUM
PYRUS C. 'BRAD-FORD'	BRAD-FORD PEAR	15 GALLON	MEDIUM
PYRUS KAWAKAWA	EVERGREEN PEAR	15 GALLON	MEDIUM
VITEX AGNUS-CASTUS	GOASTIE TREE	15 GALLON	LOW
STANDARDS AND TOPIARIES			
LIGUSTRUM JAPONICUM '3-TIER'	JAPANESE PRIVET TOPIARY	15 GALLON	MEDIUM
ROSA STANDARD	ORNAMENTAL TREE ROSE	5 GALLON	MEDIUM
THUNIA TOPIARIES	ARBORVITAE TOPIARY	15 GALLON	MEDIUM
SHRUBS - FRONTYARD			
ABELIA G. PROSTRATA	DWARF GLOSSY ABELIA	5 GALLON	MEDIUM
AGAPANTHUS AFRICANUS	LILY-OF-THE-NILE	1 GALLON	MEDIUM
ARBITUS U. COMPACTA	COMPACT STRAWBERRY TREE	5 GALLON	LOW
ARCTOSTAPHYLOS 'EMERALD CARPET'	EMERALD CARPET	1 GALLON	LOW
ARCTOSTAPHYLOS 'EMERALD CARPET'	EMERALD CARPET	1 GALLON	LOW
AZALEA 'SOUTHERN INDICA'	SUN AZALEA	5 GALLON	MEDIUM
BUDDLEIA DAVIDII	BUTTERFLY BUSH	5 GALLON	LOW
BUXUS JAPONICA	BOXWOOD	1 GALLON	MEDIUM
CAMELLIA SASANOWA	CAMELLIA	5 GALLON	MEDIUM
CAREX OPAECA	LOTUS SEED	1 GALLON	MEDIUM
CISTUS HYBRIDUS	ROCK ROSE	5 GALLON	LOW
DIETES BICOLOR	FORTNIGHT LILY	5 GALLON	LOW
DIETES IRIDIODES	FORTNIGHT LILY	5 GALLON	LOW
DIOSMA PULCHRUM	BREATH-OF-HEAVEN	5 GALLON	MEDIUM
ERIGERON KARVINIS/ANUS	SANTA BARBARA DAISY	5 GALLON	LOW
ERYTHRONIUM 'BOWLES MAUI'	MAUIE CLUSTERS	5 GALLON	LOW
ESCALLONIA 'FRANCOIS'	ESCALLONIA	5 GALLON	MEDIUM
EUNYMIUS 'M. PROPHETUS'	BOXLEAF EUNYMIUS	5 GALLON	LOW
EUNYMIUS P. 'MUNCHING'	DIWAR EUNYMIUS	5 GALLON	LOW
FEJJOA SELLOWIANA	PINEAPPLE GUAVA	5 GALLON	LOW
FESTUCA GLAUCA	BLUE FESCUE	1 GALLON	LOW
GERANIUM 'JOHNSON'S BLUE'	GERANIUM	5 GALLON	MEDIUM
GREVILLEA 'NOEL'	WOOLY GREVILLEA	5 GALLON	LOW
HELIOTROPIS 'SEMPERVIRENS'	BLUE OAT GRASS	1 GALLON	LOW
HEMEROCALLIS HYBRIDS	DAYLILY	1 GALLON	MEDIUM
ILEX C. 'BURFORD'	BURFORD HOLLY	5 GALLON	LOW
ILEX C. 'BURFORD'	DWARF YAPON HOLLY	5 GALLON	LOW
LANTANA MONTEVEGENSIS	TRAILING LANTANA	5 GALLON	LOW
LAVATERA MARTIMA	TREE MALLOW	5 GALLON	LOW
LAVANOLA A. 'MUNSTEAD'	ENGLISH LAVANDER	1 GALLON	LOW
LAVANOLA A. 'STOCHES'	SPANISH LAVANDER	1 GALLON	LOW
LIGUSTRUM J. 'TEXANUM'	JAPANESE PRIVET	5 GALLON	MEDIUM
LIPIDOTE GIGANTEA	GIANT LILY TURF	1 GALLON	LOW
LOROPETALUM CHINENSE	CHINESE FRINGE FLOWER	5 GALLON	LOW
LOROPETALUM C. 'RAZZLEBERRY'	RED FRINGE FLOWER	5 GALLON	LOW
MULLENBERGIA REGENS	DEER GRASS	5 GALLON	LOW
MYRTUS C. 'COMPACTA'	DWARF MYRTLE	5 GALLON	LOW
NANDINA DOMESTICA	HEAVENLY BAMBOO	5 GALLON	LOW
NANDINA O. 'COMPACTA'	DWARF HEAVENLY BAMBOO	5 GALLON	LOW
NANDINA O. 'GULF STREAM'	GULF STREAM BAMBOO	1 GALLON	LOW
NEPETA FAASSENI	CATMINT	1 GALLON	LOW
NEROLIUM OLEANDER	OLEANDER	5 GALLON	LOW
OLEA E. 'LITTLE OLIVE'	DWARF OLIVE	5 GALLON	LOW
PENNSYLIUM 'AMELIN'	DWARF FOUNTAIN GRASS	1 GALLON	LOW
PHORMIUM T. 'MAORI MAIDEN'	NEW ZEALAND FLAX	5 GALLON	LOW
PITOSPORUM 'WHEELERS DWARF'	DWARF TOB RA	1 GALLON	MEDIUM
PITOSPORUM T. 'VAREGATA'	VAREGATED TOB RA	5 GALLON	MEDIUM
PODOCARPUS GRACILOR	FERM PINE	5 GALLON	MEDIUM
PRUNUS 'BRIGHT B TIGHT'	BRIGHT B TIGHT LAUREL	5 GALLON	LOW
PYRACANTHA SANTA CRUZ	PROSTRATE FIRETHORN	1 GALLON	LOW
RHAPHIDOLEPS I. 'BALLEPINA'	INDIA HAWTHORN	1 GALLON	LOW
RHAPHIDOLEPS I. 'WHITE ENCHANTRESS'	INDIA HAWTHORN	5 GALLON	LOW
ROSA 'CECILE BRUNNER'	CECILE BRUNNER ROSE	5 GALLON	LOW
ROSMARINUS OFFICINALIS	ROSEMARY	5 GALLON	LOW
ROSA ME OSLAND WHITE	WHITE SHRUB ROSE	5 GALLON	MEDIUM
ROSA FLOWER CARPET PINK	GROUND COVER ROSE	1 GALLON	MEDIUM
SOLLIA HETEROPHYLLA	BLUEBELL CREEPER	1 GALLON	LOW
STRELITZIA REGINAE	BIRD-OF-PARADISE	5 GALLON	MEDIUM
SYRINGA VILGARS	COMMON LILAC	5 GALLON	LOW
TRACHELOSPERMUM JASMINOIDES	STAR JASMINE	5 GALLON	MEDIUM
VIBURNUM TINUS	LAURUSTINUS	5 GALLON	MEDIUM
XYLOSMA C. 'COMPACTA'	COMPACT XYLOSMA	5 GALLON	LOW
GROUNDCOVERS			
SPHOPOGON 'NANUS'	DWARF MONDO GRASS	1 GALLON	LOW
ARCTOSTAPHYLOS D. 'EMERALD CARPET'	EMERALD CARPET	1 GALLON	LOW
MYOPORUM PARVIFOLIUM	MYOPORIUM	1 GALLON	LOW
ROSMARINUS PROSTRATUS	ROSEMARY	1 GALLON	LOW
SCAEVOLA MAUIE CLUSTERS	FAN FLOWER	1 GALLON	LOW

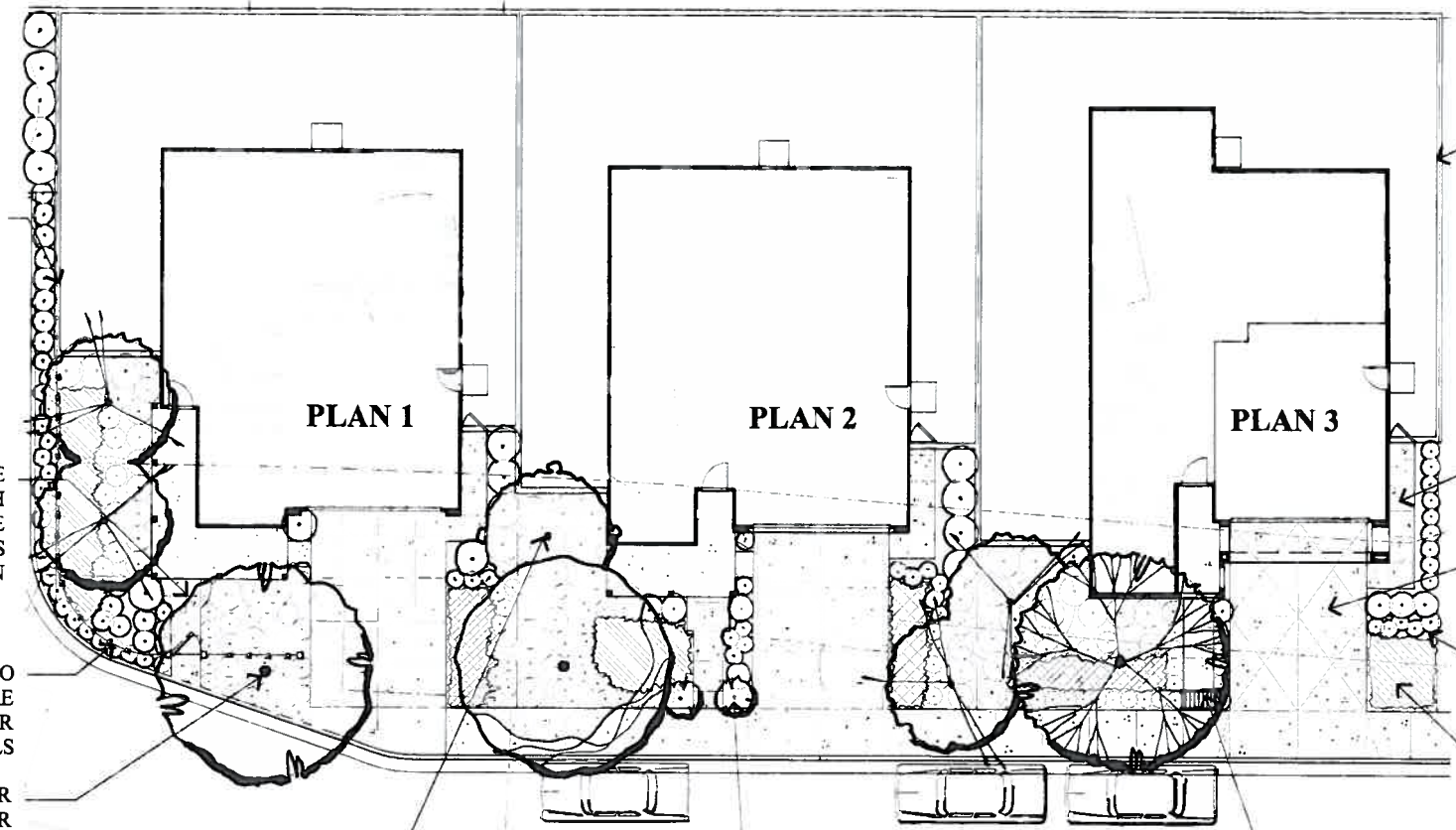

6' HIGH WOOD FENCE TYPICAL-REFER TO SHEET L3 FOR DETAIL

3'-6" WIDE CONCRETE ENTRY WALK WITH DECORATIVE SCORING-STYLE VARIES PER PLAN

PICKET FENCE AND GATE TO MATCH PORCH ARCHITECTURE - REFER TO SHEET L3 FOR DETAILS

STREET TREE - REFER TO PLANT PALETTE FOR SPECIES

ACCENT TREE TYPICAL-REFER TO PLANT PALETTE FOR SPECIES

SHRUB STANDARDS OR TOPIARIES AT FRONT WALK - REFER TO PLANT PALETTE FOR SPECIES

6' HIGH WOOD FENCE TYPICAL-REFER TO SHEET L3 FOR DETAIL

3' WIDE CONCRETE GARAGE WALKWAY

SCORED CONCRETE DRIVEWAY - PATTERN VARIES PER PLAN

SHRUB PLANTING TYPICAL REFER TO PLANTING PALETTE - SPECIES VARY PER ARCHITECTURAL STYLE

GROUND COVER PLANTING TYPICAL-REFER TO PLANT PALETTE FOR SPECIES

ROSE ARCH AT COTTAGE STYLE ARCHITECTURE OR WOOD BROW AT CRAFTSMAN STYLE ARCHITECTURE-REFER TO SHEET L3 FOR DETAILS

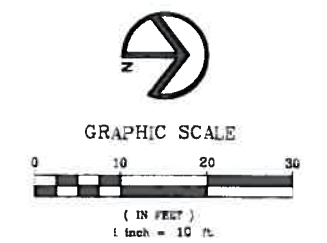

GENERAL NOTES

- ALL STREET TREES TO BE PLANTED WITH ROOT BARRIERS PER CITY OF PLEASANTON STANDARD DETAILS
- ALL TREES TO RECEIVE TREE STAKES PER CITY OF PLEASANTON STANDARD DETAILS
- ALL PLANTING TO CONFORM TO CITY OF PLEASANTON WATER EFFICIENT LANDSCAPE ORDINANCE.

RIPLEY DESIGN GROUP, INC.
LANDSCAPE ARCHITECTURE
LAND PLANNING
 1615 BONANZA STREET
 SUITE 314
 WALNUT CREEK, CA 94596
 TEL: 925.938.7377
 FAX: 925.938.7436

PONDEROSA HOMES

Preliminary Landscape Streetscape

Wagner Property
 Pleasanton, California
L2
 May 22, 2013

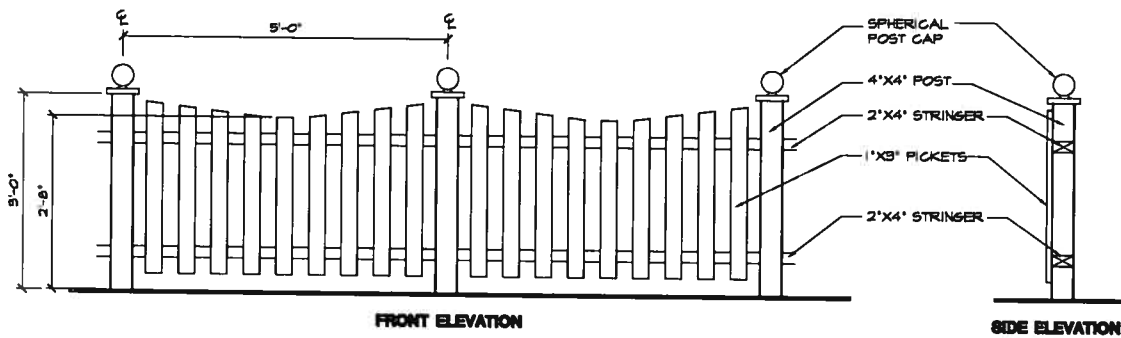

PICKET FENCE

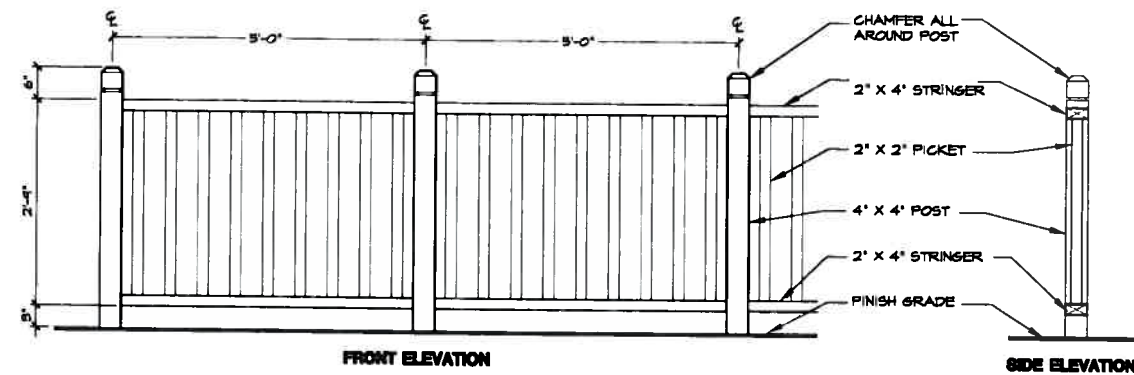

PICKET FENCE

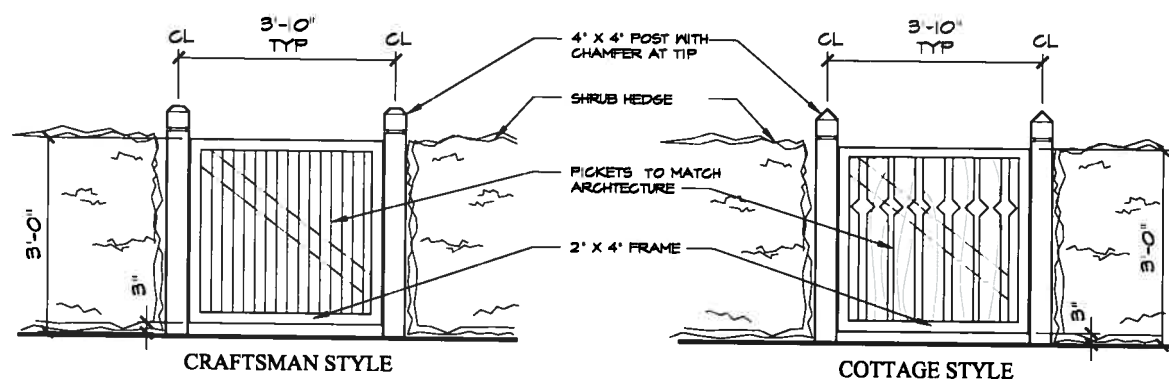

WOOD GARDEN GATES

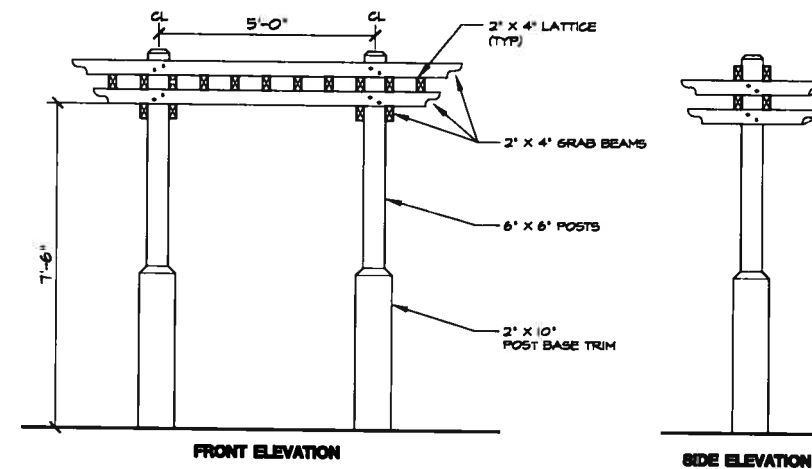

**WOOD BROW
AT COTTAGE STYLE ARCHITECTURE**

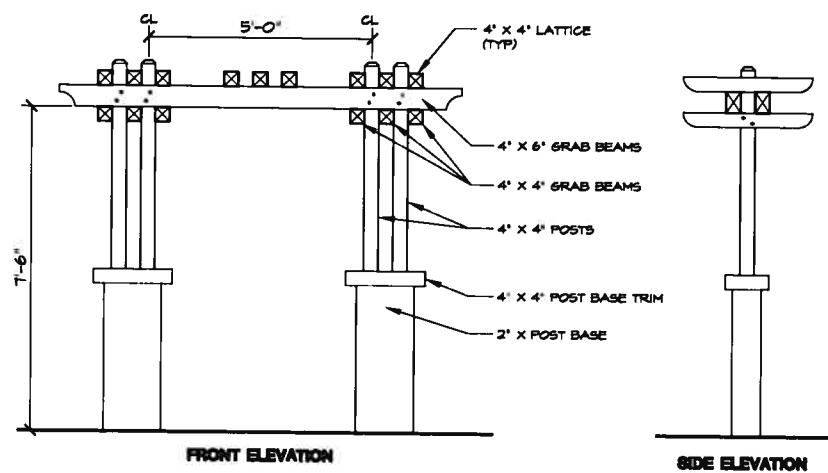

**WOOD BROW
AT CRAFTSMAN STYLE ARCHITECTURE**

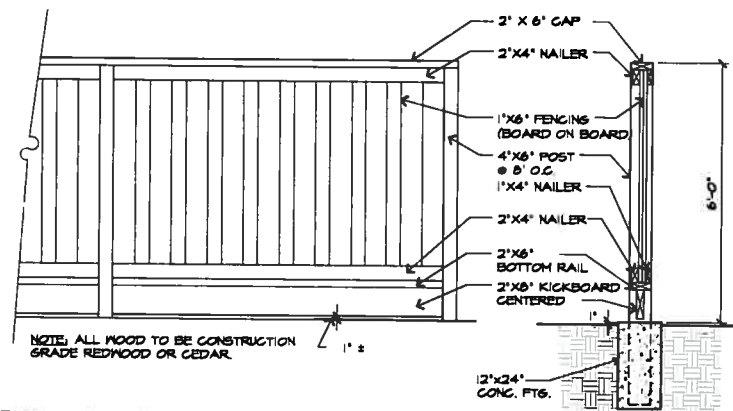

WOOD FENCE

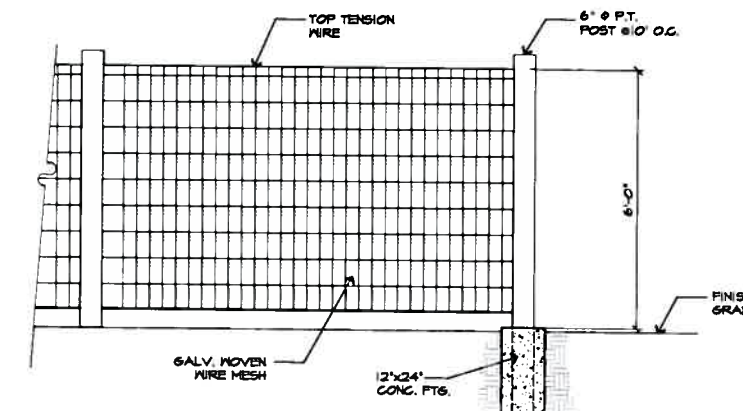

OPEN WIRE VIEW FENCE

PONDEROSA HOMES

Preliminary Landscape Details

Wagner Property

Pleasanton, California

L3

May 22, 2013



RIPLEY DESIGN GROUP, INC.
LANDSCAPE ARCHITECTURE
LAND PLANNING
1615 BONANZA STREET
SUITE 314
WALNUT CREEK, CA 94596
TEL: 925.938.7377
FAX: 925.938.7436